

# **NetAgent**

UPS SNMP Agent

User's Manual

## **User Guide for NetAgent**

Version 6.1

NetAgent Firmware version 2.44

NetAgent 9 Firmware version 3.0

### **Copyright Information**

Copyright © 2000-2010, Mega System Technologies, Inc.

All rights reserved.

Reproduction without permission is prohibited.

### **Technical Support and Contact Information**

Mega System Technologies, Inc.

Tel: +886-2-87922060

Fax: +886-2-87922066

Web: [www.megatec.com.tw](http://www.megatec.com.tw)

E-mail: [service@megatec.com.tw](mailto:service@megatec.com.tw)

## Contents

---

<b>Chapter1. Introduction</b>	<b>1</b>
<b>Section1. Features</b>	<b>1</b>
<b>Section2. Applications</b>	<b>2</b>
2.1 NetAgent makes your UPS on the Internet	2
2.2 NetAgent Provides Shutdown Utilities	2
2.3 NetAgent II for Surrounding Monitoring	2
2.4 When we need the NetAgent?	2
<b>Section3. NetAgent Models</b>	<b>4</b>
3.1 NetAgent Models	4
3.2 Pictures of NetAgent II	6
3.3 NetAgent Package Contents	7
3.4 NetAgent II Outlook	7
3.5 NetAgent Mini OutLook	9
<b>Section4. NetAgent9 Models</b>	<b>10</b>
4.1.NetAgent 9 Models	10
4.2 Pictures of NetAgent9	11
4.3 NetAgent 9 Package Contents	12
4.4.NetAgent 9 Outlook	12
4.5 NetAgent 9 Mini Outlook	14
<b>Chapter 2. NetAgent UPS Installation</b>	<b>15</b>
<b>Chapter 3. NetAgent, UPS and Network Connection</b>	<b>16</b>
<b>Section1. Install the NetAgent II with UPS and Network</b>	<b>16</b>
1.1 For External NetAgent II	16
1.2 For Internal NetAgent II	16
<b>Section2. Install the NetAgent Mini with UPS and Network</b>	<b>17</b>
2.1 For External NetAgent Mini	17
2.2 For Internal NetAgent Mini	17
<b>Chapter 4. Using Netility Setup IP.Update Firmware</b>	<b>18</b>
<b>Section1. Install Netility</b>	<b>18</b>
<b>Section2. Using Netility</b>	<b>18</b>
<b>Chapter 5. UPS Web management by NetAgent</b>	<b>22</b>
<b>Section1. Introduction</b>	<b>22</b>

<b>Section2. NetAgent UPS Web Interface</b>	<b>22</b>
2.1 Information	24
2.1.1 System Status	25
2.1.2 Basic Information	25
2.1.3 Current Status	26
2.1.4 Remote Control	27
2.1.5 Meter/Chart	29
2.1.6 Modem Status (For 3 Ports NetAgent II only)	30
2.1.7 Environment Sensors-NetFeeler II	31
2.2 Configuration	32
2.2.1 UPS Configuration	33
2.2.2 UPS On/Off Schedule	35
2.2.3 Network	36
2.2.4. Wireless	39
2.2.5 SNMP	40
2.2.6 Email	44
2.2.7 SMS	46
2.2.8 Modem (For 3 Ports NetAgent II only)	47
NetSwitch Status	49
NetSwitch Action	50
2.2.9 WEB/Telnet	50
2.2.10 System Time	52
2.2.11 NetFeeler II (For 3 Ports NetAgent II only)	54
2.2.12 Language	55
2.3 Log Information	57
2.3.1 Event Log	57
2.3.2 SMS	59
2.3.3 Data Log	60
2.3.3 Save Data Log	62
2.4 Help	63
2.4.1 Search NetAgent	63
2.4.2 Serial Port Debug	63
<b>Chapter 6. Telnet (Remote Configuration)</b>	<b>66</b>
<b>Section1. Introduction</b>	<b>66</b>
<b>Section2. Telnet Configuration</b>	<b>66</b>
<b>Section3. Telnet Configuration</b>	<b>68</b>
<b>Chapter 7. ClientMate - Windows Shutdown Utility</b>	<b>69</b>

<b>Section1. Install ClientMate</b>	<b>69</b>
<b>Section2. Using ClientMate</b>	<b>69</b>
2.1 Config	70
2.2 Closed Files	72
2.3 About	73
2.4 Event log	73
2.5 IP address of connection	73
2.6 AC power status	74
2.7 Battery Status	74
2.8 Status History	74
<b>Chapter 8. SNMPView – Windows Based UPS Management System</b>	<b>75</b>
<b>Section1. Introduction</b>	<b>75</b>
<b>Section2. System Requirements</b>	<b>75</b>
<b>Section3. Install SNMPView</b>	<b>76</b>
<b>Section4. Using SNMPView</b>	<b>77</b>
<b>Section5. SNMPView Buttons</b>	<b>78</b>
5.1 ENUMERATE(D)	80
5.1.5 Browse Device	81
5.1.6 Export Configuration	81
5.1.7 Import Configuration	82
5.1.8 Open archive Event Log	83
5.1.9 Open archive Data Log	84
5.1.10 Quit	84
5.2 View(S)	85
5.2.1 Large Icons	85
5.2.2 Small Icons	85
5.2.3 Details	86
5.2.4 Map Background	86
5.3 Tools(P)	87
5.3.1 Settings	87
5.3.2 UPS Monitor	90
5.3.3 UPS Management	93
5.4 System(S)	94
5.4.1 Event Log	94
5.4.2 Data Log	94
5.4.3 SNMP Option	95

5.5 User(U) _____	96
5.5.1 Change Password _____	96
5.5.2 User Management _____	96
5.6 Help(H) _____	97
5.6.1 HTML Help _____	97
5.6.2 About _____	97
<b>Appendix A - Update the firmware of NetAgent UPS _____</b>	<b>98</b>
<b>Appendix B -3 Ports NetAgent II with SMS Modem _____</b>	<b>101</b>
<b>Appendix C –SMS Server with SMS Modme _____</b>	<b>105</b>

# **Chapter1. Introduction**

## **Section1. Features**

NetAgent is a new generation SNMP (Simple Network Management Protocol) monitoring product. Not only could remote control the UPS and get the current status of it, the NetAgent II –3Ports also could provide other functions, ex. connect to Modem or GSM Modem to make the monitoring possible when there is no permanent connection to Internet and sens SMS notification . The NetAgent II – 3Ports could also been used to connect to ‘NetFeeler II’, to get the temperature, humidity and water conditions. To get the condition of Smoke detector, Gas detector, door and window detector are also possible.

This product is for “Contact Closure” and “RS232” interface UPS. The communication protocol includes the Contact Closure, RS232[MegaTec], RS232[Phoenixtec], SEC 2400, SEC 9600, Three Phase, Powerware, Smart APC, EMERSON. User could also provide their own protocol to build in. NetAgent provides a simple and easy installation procedure. CD provides along with NetAgent offers several softwares to allow the user to configure IP address; central monitoring and multi shutdown on different operating systems. Other advance configurations could be accomplished in the Web browser.

Features:

- ❶ Provide SNMP MIB to monitor & control UPS
- ❷ Auto-sense 10M/100M Fast Ethernet
- ❸ Manage and configure via Telnet, Web Browser or NMS
- ❹ Support TCP/IP, UDP, SNMP, Telnet, SNTP, PPP, HTTP, SMTP Protocol
- ❺ Providing easy setup and upgrade tools via MS-Windows, just a few seconds to finish IP setting, about 1.5 minutes to upgrade firmware.
- ❻ Send SNMP TRAP ; E-mail and SMS for events notification.
- ❼ Auto email daily UPS history report
- ❽ Matches with shutdown software to protect computer’s file saving and shut down safely
- ❾ NetAgent II – 3Ports : Environment Measurement (Optional Kits), External modem dial in/out via PPP protocol or GSM/GPRS Modem

## **Section2. Applications**

### **2.1 NetAgent makes your UPS on the Internet**

When the UPS connects with NetAgent, the system manager could check each and every UPS condition by a computer with Browser installed. The manager could monitor and control the UPS by simply input the IP address of the NetAgent which connects to the UPS. When there is a power abnormal condition happens, the NetAgent could also send the trap information to the system manager to take proper action.

### **2.2 NetAgent Provides Shutdown Utilities**

When a computer on the network with the NetAgent utility installed, it could locate all the NetAgent on the network. When the UPS of this NetAgent is in AC failure condition or Battery Low condition, the operating system could close all the files on the system, and perform a gracefully shutdown. This could avoid system corrupt when a power disconnection happened.

### **2.3 NetAgent II for Surrounding Monitoring**

3Port NetAgent II could be use to connect the surrounding monitoring utility, NetFeeler II, to get the temperature/humidity/smoke/fire signals. These informations could also be revealed on the NetAgent Web page. When there is an abnormal condition happened, it could also be sent as a trap to the system manager.

### **2.4 When we need the NetAgent?**

- ❶ When we need to remote monitoring and controls the UPS conditions. For example, the system manager could use the Internet to control all the UPS conditions all over the country. When the shutdown utility is installed, the shutdown utility could close all the files and shutdown the system when a power abnormal condition happened.
- ❷ When we need to monitor surrounding conditions of the machine room, warehouse, office, ...etc. For example, the system manager could know the temperature, humidity, smoke and water condition by using the NetAgent II-3Ports version and NetFeeler II. The system manager could always know these surrounding conditions by using a Web browser.



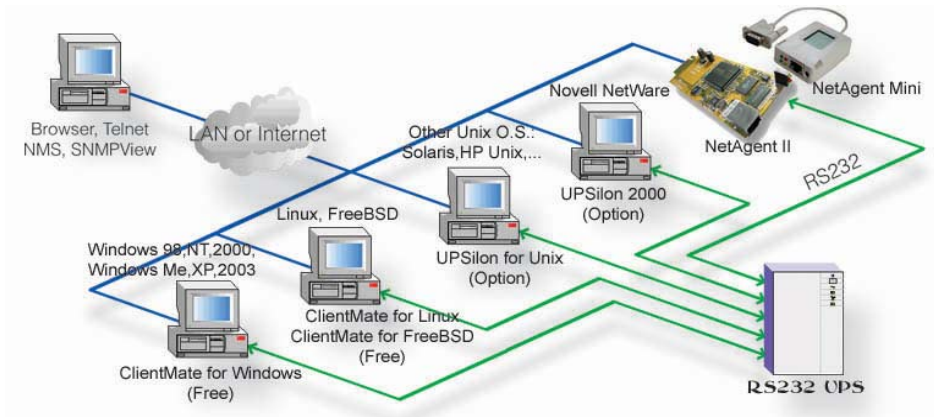

Fig.1 NetAgent connection Software

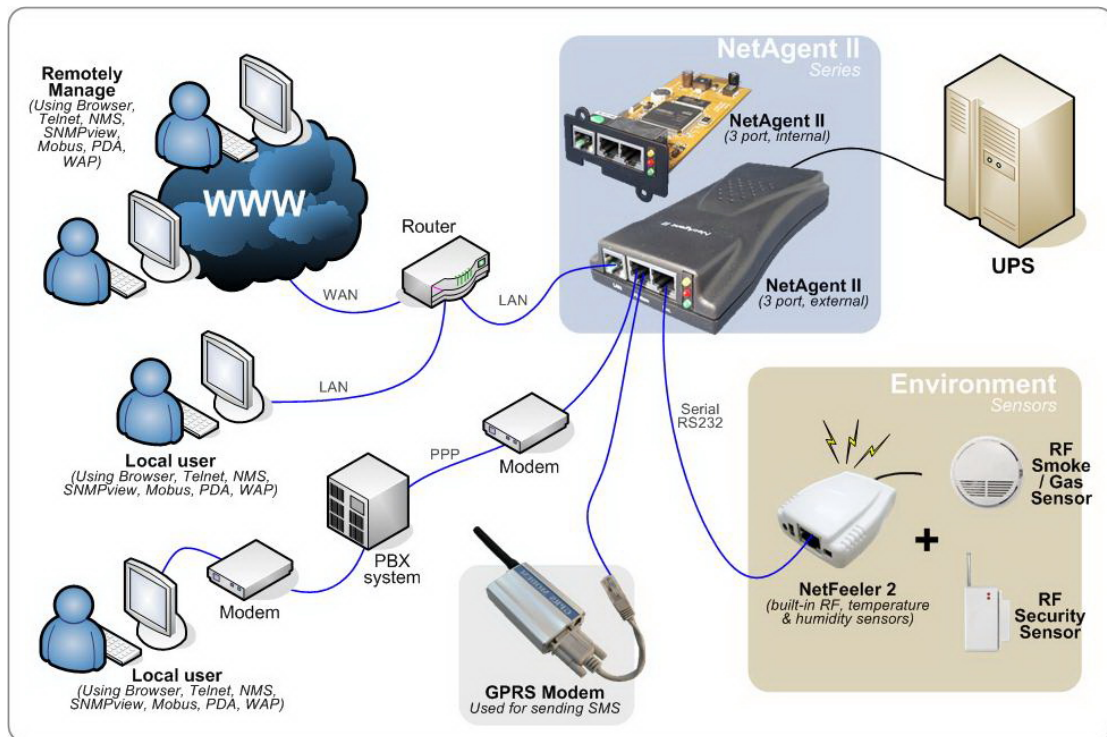

Fig.2 3 Port NetAgent II Diagram

## Section 3. NetAgent Models

### 3.1 NetAgent Models

NetAgent II Model				
P/N	Package Contents	Internal/External	1/3 Ports	1/3 phases
CP504 CT504	1. 1Port Internal card 2. NetAgent Utility CD 3. User Manual	Internal	1 Port	1/3 phases
CP503 CT503	1. 1Port External card 2. NetAgent Utility CD 3. User Manual 4. Adaptor	External		
BP505	1. 3 Port External Agent 2. NetAgent Utility CD 3. User Manual 4. M2501 Cable (for Contact Closure UPS) 5. M2502 or M2505 Cable. (for RS232 UPS) 6. M2506 Cable (for Modem) 7. 9V DC adapter	External	3 Ports	1/3 phases





NetAgent Mini Model				
P/N	Package Contents	Internal/External	1/3 Ports	1/3 phases
DP520 DT520	1. Internal NetAgent Mini 2. NetAgent Utility CD 3. User Manual	Internal	1 Port	1/3 phases
DP801 DT801	1. Internal NetAgent Mini 2. NetAgent Utility CD 3. User Manual	Internal		
DP802 DT802	1. Internal NetAgent Mini 2. NetAgent Utility CD 3. User Manual	Internal		
DP522 DT522	1. External NetAgent Mini 2. NetAgent Utility CD 3. User Manual 4. 5.3V DC adapter	External		
DP523 DT523	1. External NetAgent Mini (Dry Contact) 2. NetAgent Utility CD 3. User Manual 4. 5.3V DC adapter	External		

DP532 DT532	1. External NetAgent Mini with LCD Display 2. NetAgent Utility CD 3. User Manual 4. 5.3V DC adapter	External		
----------------	--	----------	--	--

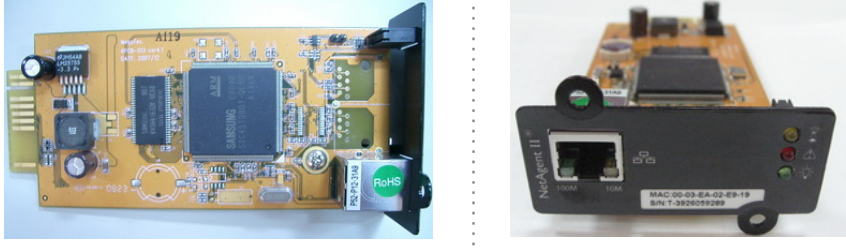

*\*DT/CT version same dimension as DP/CP.*

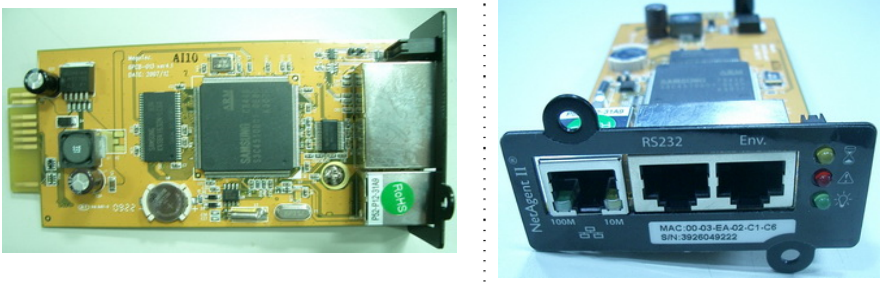
*\*DT/CT has RTC and 2MB flash to maintain correct date/time and log saving.*

### 3.2 Pictures of NetAgent II

NetAgent II(BP,CP/CT,DP/CT Series)	
CP504	 <p>Two images of the CP504 model: on the left, the yellow printed circuit board (PCB) with various components and a RoHS label; on the right, the black plastic housing of the device with a LAN port and a label showing MAC and SN numbers.</p>
CP503	 <p>Two images of the CP503 model: on the left, the black plastic housing showing RS232 and +9V DC ports; on the right, the black plastic housing showing LAN, Modem, and Ext ports.</p>
BP506	 <p>Two images of the BP506 model: on the left, the yellow PCB with a RoHS label; on the right, the black plastic housing with RS232, Env, and LAN ports, and a label with MAC and SN numbers.</p>
BP505	 <p>Two images of the BP505 model: on the left, the black plastic housing showing RS232 and +9V DC ports; on the right, the black plastic housing showing LAN, Modem, and Ext ports.</p>

NetAgent Mini (DP Series)		
DP520	DP522	DP532
 <p>Image of the DP520 model, a small white plastic device with a LAN port and a label.</p>	 <p>Image of the DP522 model, a small grey plastic device with a serial port and a LAN port.</p>	 <p>Image of the DP532 model, a small grey plastic device with a serial port and a LAN port.</p>

 <p>Image of the DP801 model, a small black plastic device with a LAN port and a label.</p>	 <p>Image of the DP802 model, a small black plastic device with a LAN port and a label.</p>
--	--

### 3.3 NetAgent Package Contents

❶ NetAgent Utility CD, including:

- ◆ Netility: Configure NetAgent IP address, update firmware
- ◆ ClientMate: Windows, Linux, FreeBSD shutdown utility.
- ◆ SNMPView: Windows platform multiple NetAgent UPS management software.
- ◆ SMS Server: SMS Notification
- ◆ UPS MIB: MIB file for the Network Management System
- ◆ Time Server: Time adjustment utility
- ◆ And NetAgent installation/users manual

❷ M2501 Cable: For external NetAgent II connection to contact closure UPS

❸ M2502 (or M2505) Cable: For external NetAgent II connection to RS-232 UPS.

❹ M2506 Cable: For connection 3Port NetAgent and Modem.

❺ 9V DC Adapter: For External NetAgent II

❻ 5.3V DC Adapter: For External NetAgent Mini

### 3.4 NetAgent II Outlook

◆ 1 Port NetAgent (Internal / External):

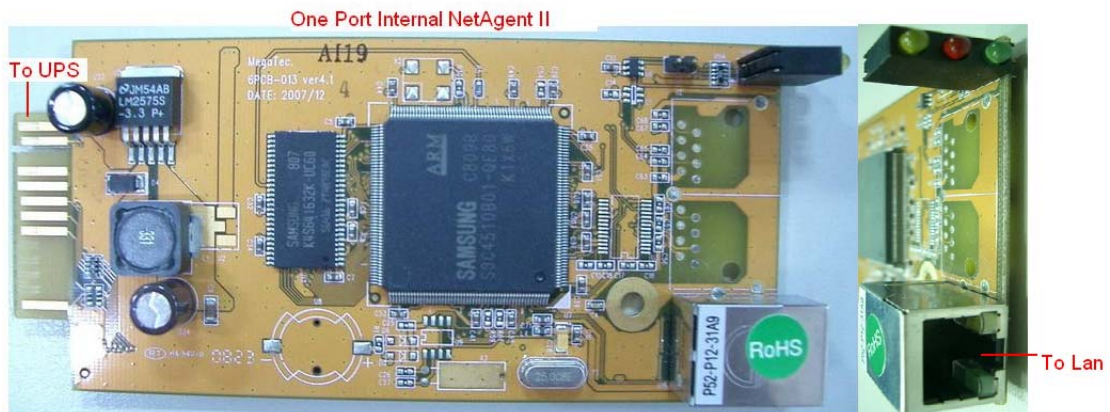

◆ 3 Ports NetAgent (Internal / External) :



LED Table			
Yellow	Red	Green	Status
Solid Off	Solid Off	Solid ON	Power ON
Flashing	Solid ON	Solid ON	System initial
Solid ON	Solid Off	Solid ON	Normal operation
Solid ON	Flashing	Solid ON	No connection to UPS
Flashing	Flashing	Solid ON	Writing data to flash memory
Green light : Power state			
Red light : Connection state with UPS			

Fig.2 NetAgent II Out looking

### 3.5 NetAgent Mini Outlook

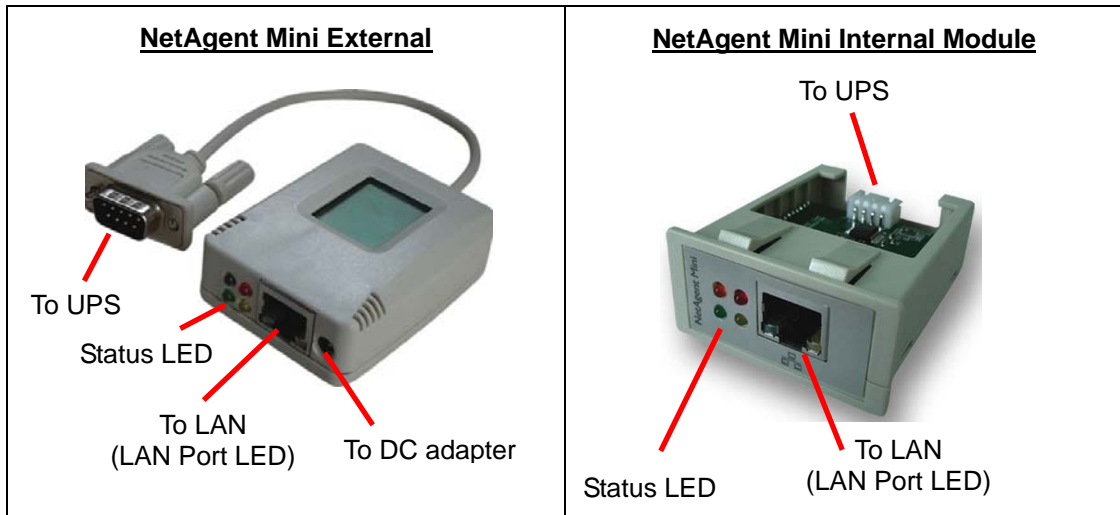

Light signal application of NetAgent Mini - Status LED		
Light color	Signal definition	Condition description
Green	Power state	On: Normal power
Red	Connection state with UPS	Flash: no connection with UPS
Orange	Correspondence state	Light flashes when Netagent transmits command to UPS

Light signal application of NetAgent Mini - LAN Port LED	
Light color	Condition description
Green	On: Internet correspond speed is 100M Flash: Data transmmiting
Yellow	On: Internet correspond speed is 10M Flash: Data transmmiting

Fig.3 NetAgent Mini Out looking

## Section 4. NetAgent9 Models

### 4.1. NetAgent 9 Models

NetAgent 9 Model				
P/N	Package Content	Internal/External	1/3Ports	1/3Phase
BX505	<ol style="list-style-type: none"> <li>1. 3 Ports External Agent</li> <li>2. NetAgent Utility CD</li> <li>3. User Manual</li> <li>4. M2501 Cable (for Contact Closure UPS)</li> <li>5. M2502 or M2505 Cable. (for RS232 UPS)</li> <li>6. M2506 Cable (for Modem)</li> <li>7. 9V DC adapter</li> </ol>	External	3Ports	1/3 Phase
BX506	<ol style="list-style-type: none"> <li>1. 3 Port Internal card</li> <li>2. NetAgent Utility CD</li> <li>3. User Manual</li> <li>3. M2506 Cable (for Modem)</li> </ol>	Internal	3Ports	
CX503	<ol style="list-style-type: none"> <li>1. 1Port External card</li> <li>2. NetAgent Utility CD</li> <li>3. User Manual</li> <li>4. M2501 Cable (for Contact Closure UPS)</li> <li>5. M2502 or M2505 Cable. (for RS232 UPS)</li> <li>6. Adaptor</li> </ol>	External	1Port	
CX504	<ol style="list-style-type: none"> <li>1. 1Port Internal card</li> <li>2. NetAgent Utility CD</li> <li>3. User Manual</li> </ol>	Internal	1Port	
DX520	<ol style="list-style-type: none"> <li>1. Internal NetAgent Mini</li> <li>2. NetAgent Utility CD</li> <li>3. User Manual</li> </ol>	Internal	1 Port	
DX801	<ol style="list-style-type: none"> <li>1. Internal NetAgent Mini</li> <li>2. NetAgent Utility CD</li> <li>3. User Manual</li> </ol>	Internal	1 Port	



## 4.2 Pictures of NetAgent9

NetAgent 9(CX / BX Series)		
CX504		
CX503		
BX506		
BX505		
NetAgent 9 Mini (DX Series)		
DX520	DX801	
		

### 4.3 NetAgent 9 Package Contents

- ❶ NetAgent Utility CD, including:
  - ◆ Netility: Configure NetAgent IP address, update firmware
  - ◆ ClientMate: Windows, Linux, FreeBSD shutdown utility.
  - ◆ SNMPView: Windows platform multiple NetAgent UPS management software.
  - ◆ SMS Server: SMS Notification
  - ◆ UPS MIB: MIB file for the Network Management System
  - ◆ Time Server: Time adjustment utility
  - ◆ And NetAgent installation/users manual
- ❷ M2501 Cable: For external NetAgent II connection to contact closure UPS
- ❸ M2502 (or M2505) Cable: For external NetAgent II connection to RS-232 UPS.
- ❹ M2506 Cable: For connection 3Port NetAgent and Modem.
- ❺ 9V DC Adapter: For External NetAgent II
- ❻ 5.3V DC Adapter: For External NetAgent Mini

### 4.4. NetAgent 9 Outlook

- ◆ 1 Port NetAgent (Internal / External)

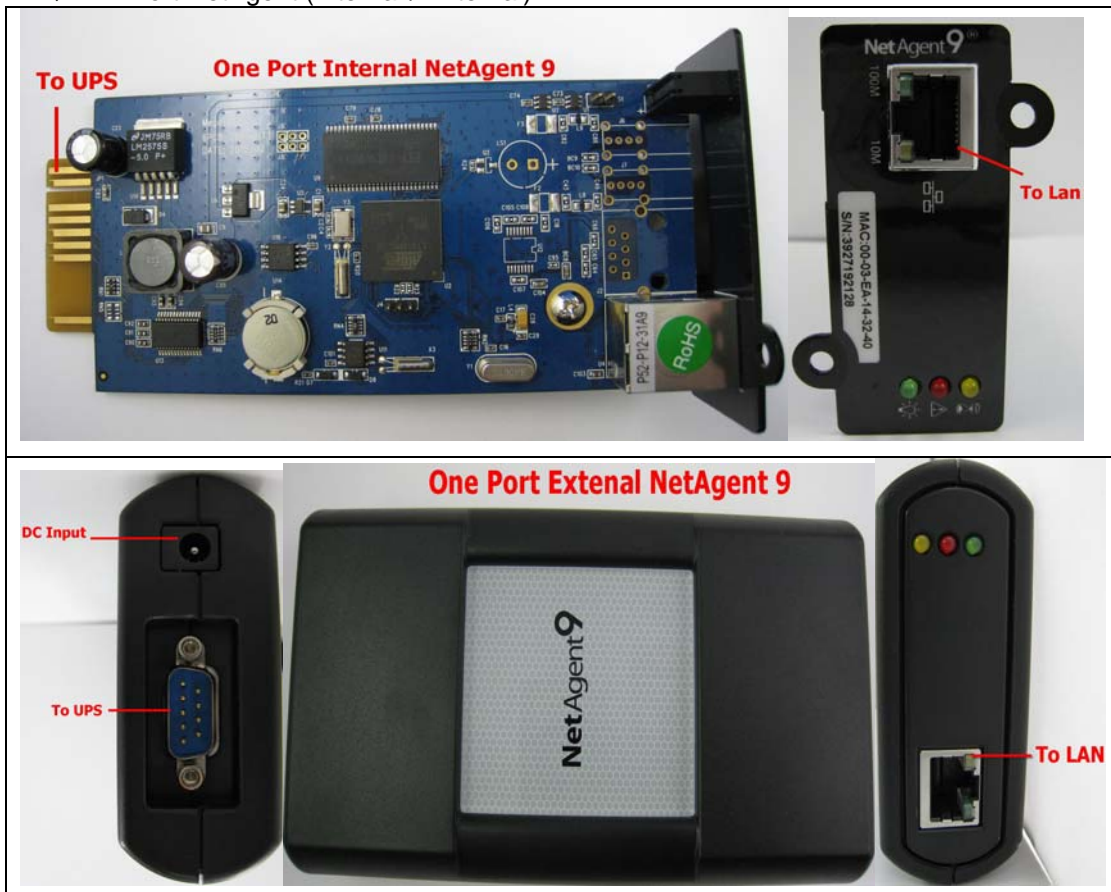

◆ 3 Ports NetAgent (Internal / External) :



LED Table			
Yellow	Red	Green	Status
Solid Off	Solid Off	Solid ON	Power ON
Flashing	Solid ON	Solid ON	System initial
Solid ON	Solid Off	Solid ON	Normal operation
Solid ON	Flashing	Solid ON	No connection to UPS
Flashing	Flashing	Solid ON	Writing data to flash memory
Green light : Power state			
Red light : Connection state with UPS			

## 4.5 NetAgent 9 Mini Outlook

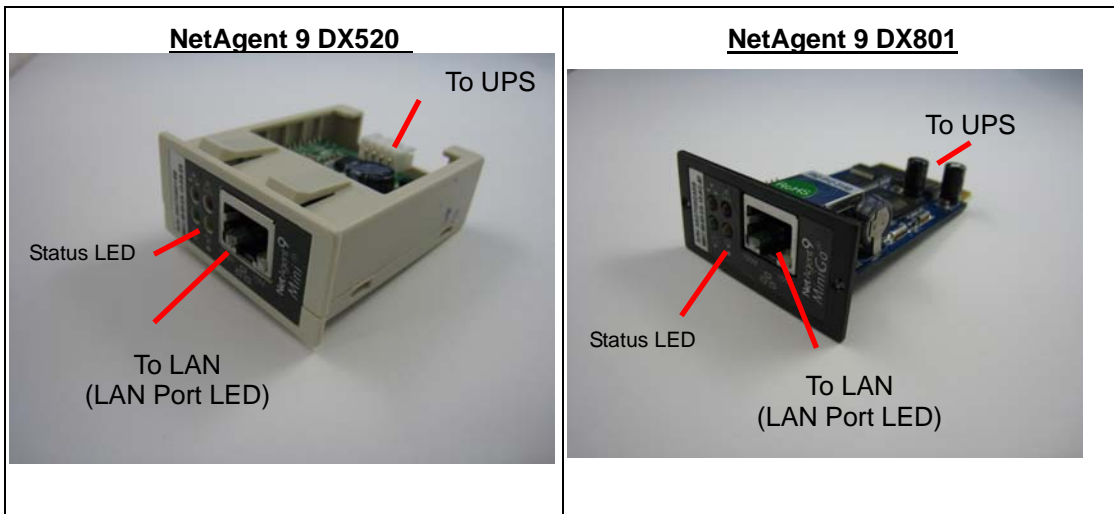

Light signal application of NetAgent 9 Mini - Status LED		
Light color	Signal definition	Condition description
Green	Power state	On: Normal power
Red	Connection state with UPS	Flash: no connection with UPS
Orange	Correspondence state	Light flashes when Netagent transmits command to UPS

Light signal application of NetAgent 9 Mini - LAN Port LED	
Light color	Condition description
Green	On: Internet correspond speed is 100M Flash: Data transmmiting
Yellow	On: Internet correspond speed is 10M Flash: Data transmmiting

## Chapter 2. NetAgent UPS Installation

Before using the NetAgent, the proper hardware and software configuration is necessary. Hardware installation is to connect the NetAgent and UPS and network. Software configuration includes the IP address. Firmware upgrade. Or using the Browser or Telnet for configuration.

You could also install the shutdown utility – ClientMate to protect your Windows operating system. And also could use the UPS management software – SNMPView, to control and management multiple UPS on the network.

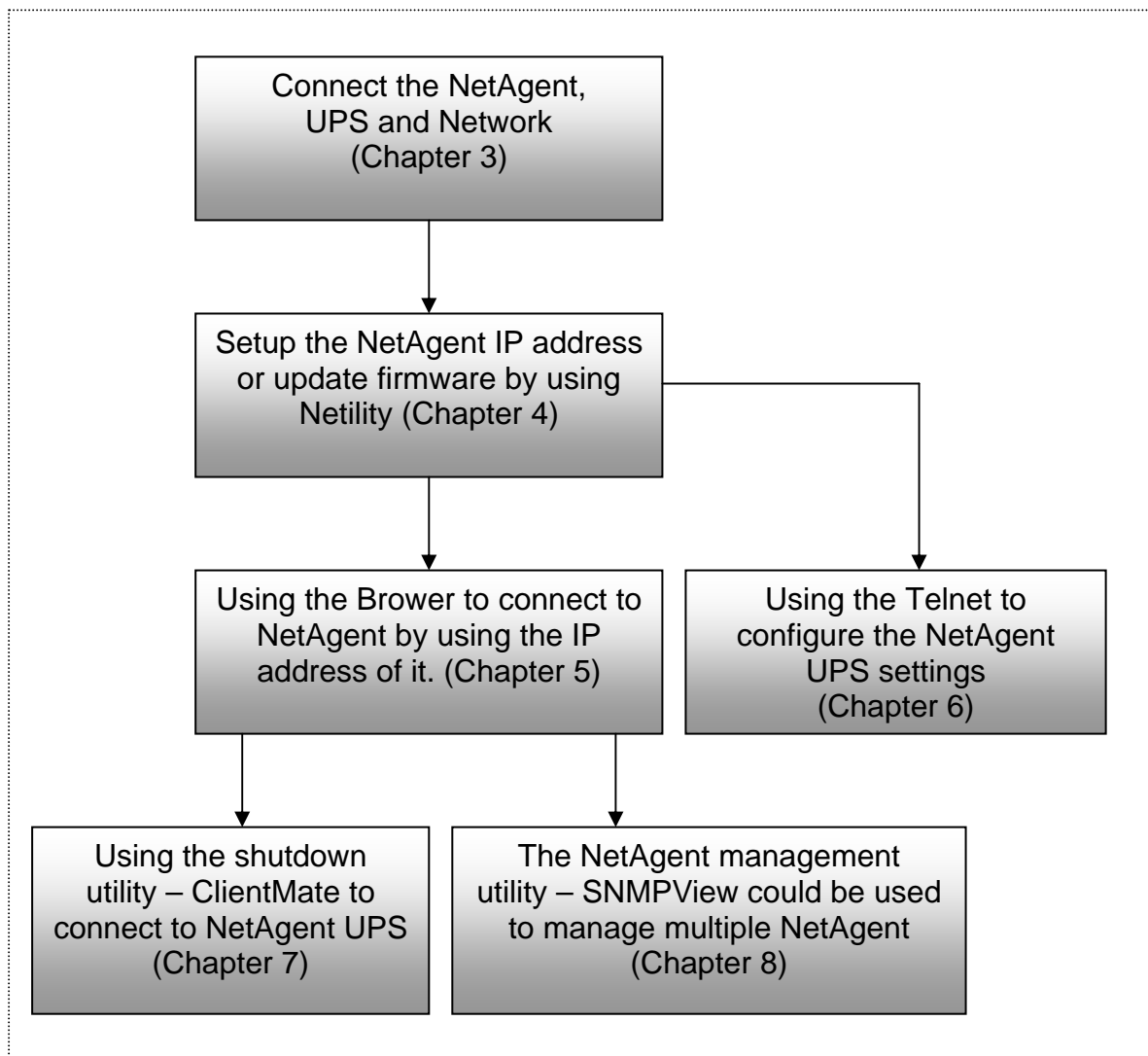

Fig.4 NetAgent UPS installation flowchart

## Chapter 3. NetAgent, UPS and Network Connection

NetAgent II and NetAgent Mini provides External and Internal model for different UPS interface requirement. Please reference the following description for detailed information of UPS and network connection.

### Section1. Install the NetAgent II with UPS and Network

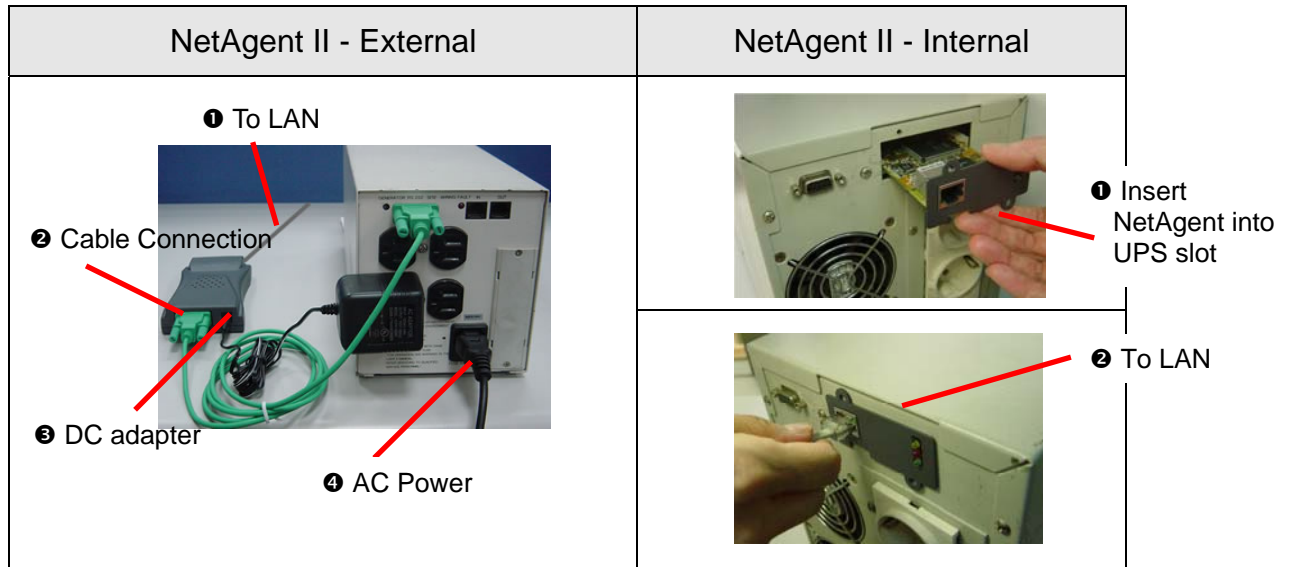

Fig.5 NetAgent II Installation

#### 1.1 For External NetAgent II

- 1 Connect the NetAgent II Adapter to LAN, using the appropriate UTP port.
- 2 Connect the specified serial cable (M2501/M2502/M2505) from NetAgent II Adapter to the serial port of UPS.
- 3 Plug supplied AC adapter to the wall socket, the other side connection with NetAgent Adapter.
- 4 UPS with AC

#### 1.2 For Internal NetAgent II

- 1 Insert the Net Agent Card into the slot of UPS.
- 2 Connect the Net Agent Card to LAN, using the appropriate UTP port.

## Section2. Install the NetAgent Mini with UPS and Network

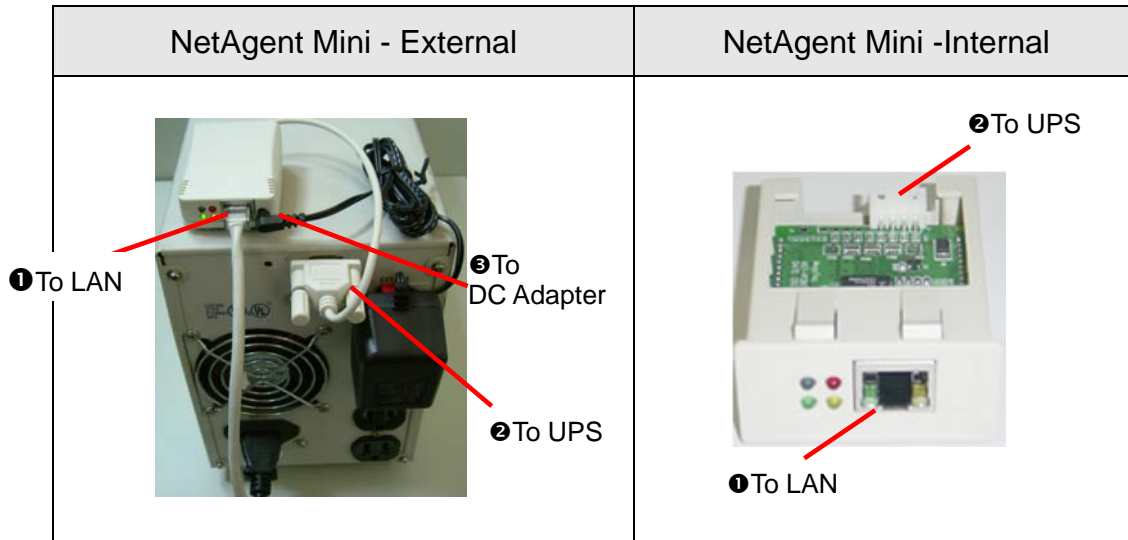

### 2.1 For External NetAgent Mini

- ① Connect the NetAgent Mini to LAN, using the UTP port.
- ② Connect the cable from NetAgent Mini to the serial port of UPS.
- ③ Plug the DC adapter to UPS outlet, the DC plug connected with NetAgent Mini.

### 2.2 For Internal NetAgent Mini

- ① Please make sure the connector direction of the cable is correct before connecting to the NetAgent.
- ② Connect the NetAgent module to LAN, using the UTP port.

**Warning:** Please make sure the input Voltage and Frequency of the DC power adapter (NetAgent II – DC 9V / NetAgent Mini – DC 6V or 5.3V) is correct before plug the power into!

## Chapter 4. Using Netility Setup IP.Update Firmware

### Section1. Install Netility

- ❶ Insert NetAgent Utility CD to the CD-ROM driver and execute Netility.exe.
- ❷ After complete installation, there will be a 'Netility' group in Windows 'Start' → 'Program Group'.

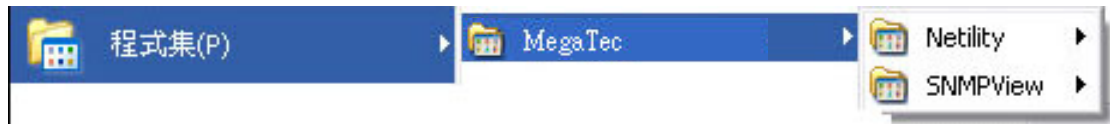

Fig.6 Netility Group

- ❸ Click "Netility" could initiate the Netility and enter the mail window for configuration.

### Section2. Using Netility

The main window of Netility is here below, left table is to show you all of NetAgent be searched in LAN; right side is function selection menu.

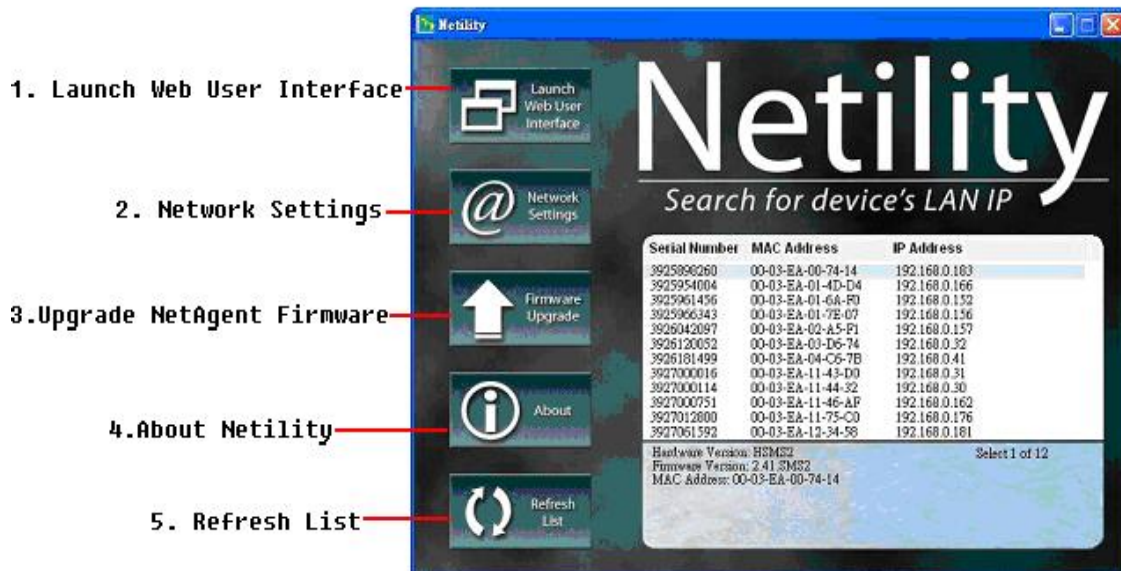

Fig.7 Netility Main Window



## ❶ Launch Device

Click Launch Device or double click the NetAgent listed in the table to launch it. Enter the Account (Login Name) and Password (Login Password) set earlier to login. If you did not configure one, then just click Apply to login.

## ❷ Network Settings

Choose the NetAgent from the right of the screen, then click “Configure”, would shows the following setting page.

### IP Address:Set IP address for Netagent UPS

When use at the first time, please set IP address; subnet mask; and gateway. After setting, enter IP address from Telnet or Browser to connect to NetAgent’s website.



Fig.8 Netility Configure

When using DHCP or BOOTTP to set up IP address, IP address, Subnet Mask and Gateway would receive directly by the system.

Fig.8 Netility : Set IP address for NetAgent UPS

### Advanced:Advanced Netagent UPS Setting

In order to ensure the secure management of UPS, Netility provides two protecting function:

#### Management Protocol

Netagent UPS provides HTTP/HTTPS(WEB) and Telnet to reference any related parameter setting for the manager. Concerning with security, the manager could build use openly or any advance port setting methods. Followings are the description:

1. At advanced setting, two functions were set as activated by using port number 80 and 23 for Http and Telnet. As for Https and SSH are 443 and 22.
2. Untick means not using the function.

3. When set to the other port value, full IP Address must be entered in order to login to the website or Telnet.

For example,

- ☞ Set 81 as HTTP port number, then <http://192.168.0.177:81> must be typed at the web address to proceed to Netagent UPS's website.
- ☞ Set 23 as Telnet port number, then "192.168.0.177:24" must be typed at Telnet to proceed to the Telnet screen of NetAgent UPS.

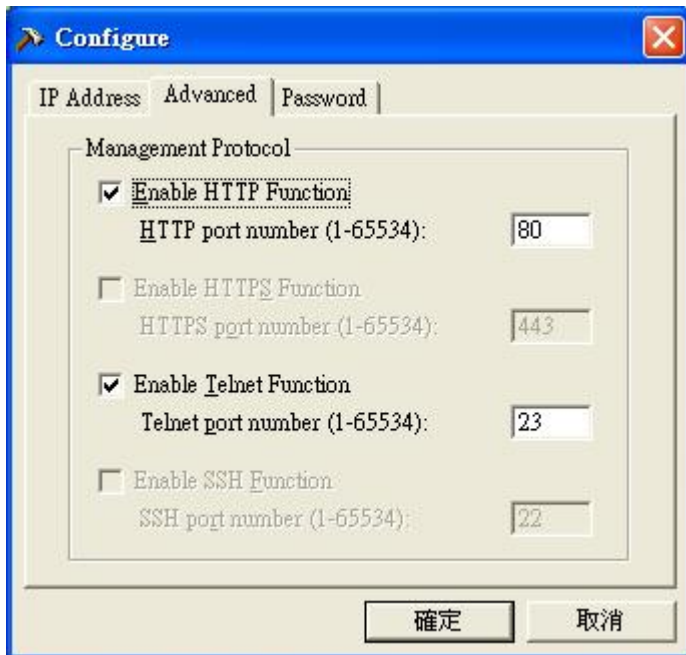

Fig 9. Netility Advanced

### Netility Password

After password setting here, there is no way to give any command to NetAgent by Netility software without user's password. **(NB. If lose this password, Netagent UPS will never be able to complete any upgrade process.)**

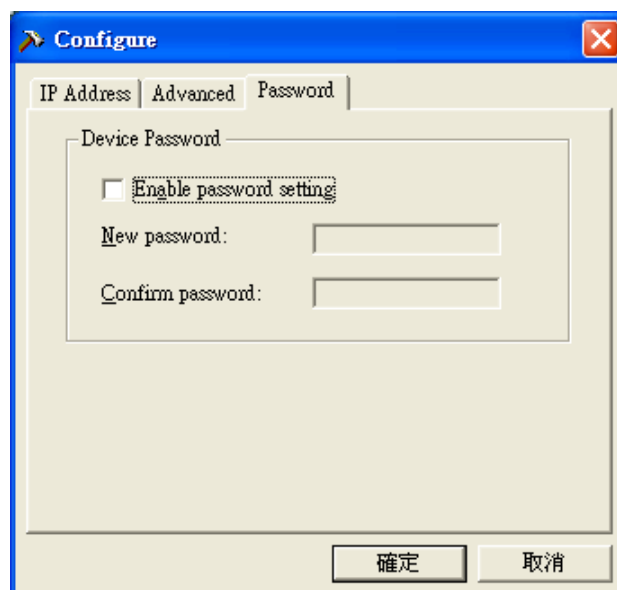

Fig.10 Netility : Advanced setting of Netagent UPS

### ③ Firmware Upgrade

NetAgent offer convenient firmware upgrade function. When you are going to upgrade firmware, click **Download Firmware** from NetAgent Setup menu, click “Browser” select new firmware file (\*.bin) and press “Start”. Thus, Net Agent’s Red LED and Yellow LED flashing alternative means the firmware is upgrading. After upgrade completed, Net Agent will auto reboot. To upgrade multi NetAgent with same firmware, hold on “shift” or Ctrl” and choose the NetAgent device from Netility list.

(Please connect to the <http://www.megatec.com.tw> for the latest firmware) If multi upgrade, select When upgrade firmware to multi NetAgent,

Note:Net Agent provided well-considerable protection function. If uploading was interrupted and raised data in incomplete, Net Agent will keep its default to avoid of complete data loss. In the case, just repeat “firmware upload” as well.

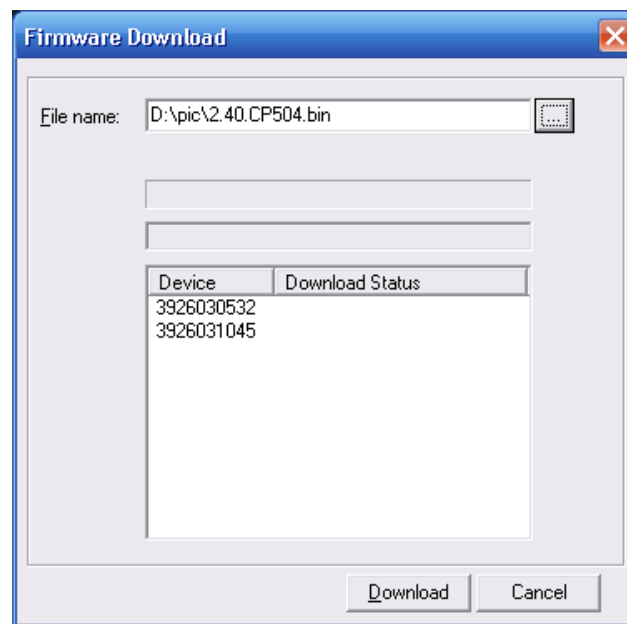

Fig.11 Netility : Update NetAgent UPS firmware

### ④ About - Netility version examined

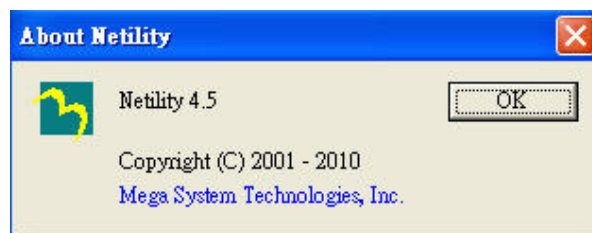

Fig.12 Netility version examined

### ⑤ Refresh List - Search Lan’s Netagent UPS manually



Netility would search all the available NetAgent from Lan automatically, or the user could search manually by click on “Search NetAgent”.

## Chapter 5. UPS Web management by NetAgent

### Section1. Introduction

After finishing NetAgent installation, including hardware installation and IP setting, you are now able to go to NetAgent web site to monitor and control UPS by inputting NetAgent IP address in Browser.

- 1 Starting the Web Brower (Netscape or Internet Explore)
- 2 Enter the NetAgent IP Address (Which is setting on Netility, e.g. 192.168.0.156).

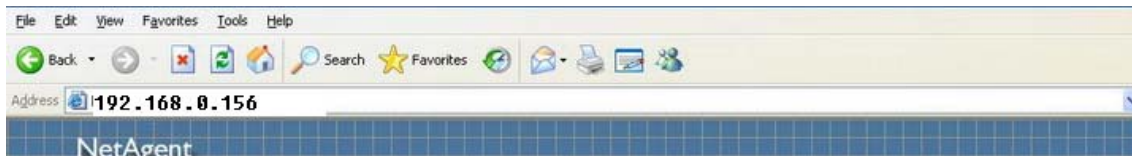

Fig.13 Input NetAgent UPS IP address

- 3 On the first screen, enter the current password. If no password has been set, just press [ENTER].



Fig.14 NetAgent UPS Login dialog

### Section2. NetAgent UPS Web Interface

Enter NetAgent UPS Web page, there are 4 main function items in the first Web page:

- 2.1 Information
- 2.2 Configuration
- 2.3 Log Information
- 2.4 Help

Enter the main function item, the sub-menu items will be shown on the left side of the page. When using this NetAgent for the first time, please enter the [Config] menu item to set all the configuration items. Then the UPS status could be correctly revealed by other pages.

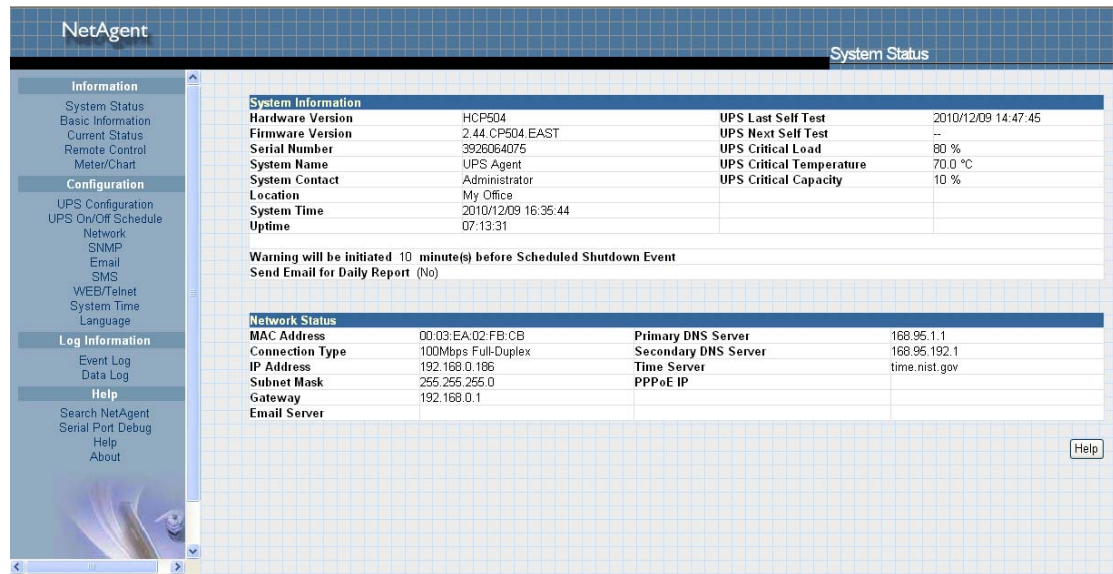

Fig.15 NetAgent UPS - single port

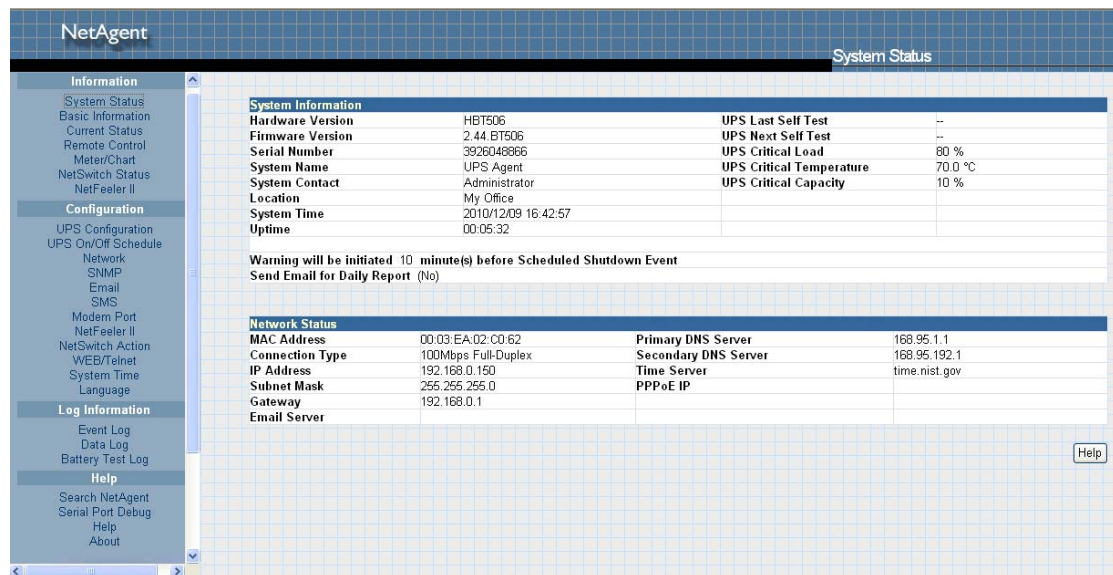

Fig.16 NetAgent UPS - 3 ports

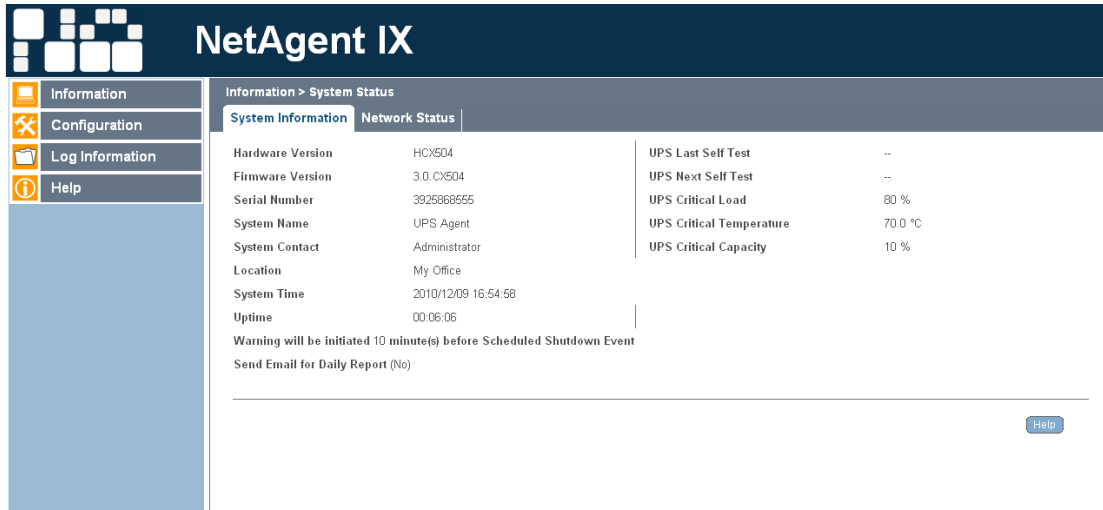

Fig. 17 NetAgent 9

## 2.1 Information

### Sub-Menu :

- 2.1.1 System Status
- 2.1.2 Basic Information
- 2.1.3 Current Status
- 2.1.4 Remote Control
- 2.1.5 Meter/Chart
- 2.1.6 Modem Status
- 2.1.7 Environment Sensors-NetFeeler II

Note: The options available on this menu depend on the NetAgent model. (e.g. "NetFeeler II" will not be display for one port.)

### 2.1.1 System Status

This page is to show NetAgent system information and Network settings. Values shown here are either provided by NetAgent itself or they are user settings from the Configuration pages.

#### System Information

This section is to show NetAgent system information. Values in Hardware Version/Firmware Version/Serial Number/System Time, are provided by NetAgent itself. Other values are user settings from the Configuration pages.

#### Network Status

This section is to show NetAgent Network settings. The MAC address is provided by NetAgent. All other values in this section are user settings from the Configuration pages.

System Information			
Hardware Version	HBP506	UPS Last Self Test	--
Firmware Version	2.42_BP506	UPS Next Self Test	--
Serial Number	3926049222	UPS Critical Load	80 %
System Name	UPS Agent	UPS Critical Temperature	70.0 °C
System Contact	Administrator	UPS Critical Capacity	10 %
Location	My Office		
System Time	2009/11/03 07:33:49		
Uptime	00:00:42		

Warning will be initiated 10 minute(s) before Scheduled Shutdown Event  
Send Email for Daily Report (No)

Network Status			
MAC Address	00:03:EA:02:C1:06	Primary DNS Server	168.95.1.1
Connection Type	100Mbps Full-Duplex	Secondary DNS Server	168.95.192.1
IP Address	192.168.0.155	Time Server	time.nist.gov
Subnet Mask	255.255.255.0	PPPoE IP	
Gateway	192.168.0.1	PPP Server	10.0.0.1
Email Server		Login IP	10.0.0.2

Fig.18 System Status

### 2.1.2 Basic Information

This page is to show UPS basic information. Values here are either provided by the UPS or they are user settings from the Configuration pages.

#### UPS Information

Information about UPS Manufacturer/UPS Firmware Version/UPS Model are provided by the UPS.

#### Battery Information

Values here are user settings from the Configuration pages.

#### Rating Information

Values here are provided by the UPS.

Basic Information	
<b>UPS Information</b>	
UPS Manufacturer	
UPS Firmware Version	V8.0
UPS Model	SC08PB03
<b>Battery Information</b>	
Date of last battery replacement	
Number of Batteries	2
Battery Charge Voltage	2.267V
<b>Rating Information</b>	
Voltage Rating	115.0V
Frequency Rating	60.0Hz
Battery Voltage Rating	12.0V

Fig.19 Basic Information

### 2.1.3 Current Status

This page is to show the UPS current status. Users can choose an interval from the drop-down box to refresh the status readings.

#### UPS Status

This section is to show the UPS power status. The abnormal status will be displayed in red when there is a power event.

#### Input Status

This section is to show the UPS input status, including AC Status/Input Voltage/Input Frequency. Values here will be shown in red when an abnormal status condition occurs.

#### Output Status

This section is to show the UPS output status, including Output Voltage/Output Status/UPS Loading. Values here will be shown in red when an abnormal status condition occurs.

#### Battery Status

This section is to show the UPS Battery Status, including Temperature/Battery Status/Battery Capacity/Battery Voltage/Time on Battery..etc. Values here will be shown in red when an abnormal status condition occurs.



Current Status	
Refresh status every	10 seconds
<b>UPS Status</b>	UPS Normal
<b>Input Status</b>	
AC Status	Normal
Input Line Voltage	112.0 V
Input Max. Line Voltage	117.0 V
Input Min. Line Voltage	102.0 V
Input Frequency	59.8 Hz
<b>Output Status</b>	
Output Voltage	112.0 V
Output Status	Line-Interactive(Standby)
UPS load	0 %
<b>Battery Status</b>	
Temperature	31.0 °C (87.8 °F)
Battery Status	Battery Normal
Battery Capacity	0 %
Battery Voltage	13.7 V
Time on Battery	00:00:00
Estimated Battery Remaining Time	00:00:00
UPS Last Self Test	--
UPS Next Self Test	--

Fig.20 Current Status

### 2.1.4 Remote Control

This page is to provide remote UPS test functions. Choose the test item, then click on 'Apply' to execute it. (Please refer to the UPS manual for individual UPS Test functions.)

If you are using a Contact Closure UPS, you will only be able to use the function 'Turn off UPS when AC Failed'.

#### 10 Second Test

This to perform 10 seconds UPS self test

#### Deep Battery Test

This function is to execute XX minute deep battery test

#### Test Until Battery Low

When execute, UPS will test Battery until battery low

#### Cancel Test

This function is to abort a test when it is executing.

#### Turn off UPS when AC failed/Reboot UPS

Selecting 'Turn off UPS when AC failed' will turn off the UPS. You can reboot the UPS by selecting 'Reboot UPS'

### Put UPS in Sleep mode for \_\_ minutes/Wake up UPS

When the UPS is put into Sleep mode, it will not provide power. The UPS will provide power again after Sleep mode time is complete.

### Wake up UPS

When execute such command, UPS will be awake from sleep

### Reboot UPS

When execute such command, UPS load would start over.

### UPS Buzzer On/Off

This is to trigger UPS buzzer On. If its ON already, execute such command will set it OFF

The screenshot displays a web-based interface titled "Remote Control" with a grid background. It features two main sections: "UPS Testing" and "Miscellaneous".

**UPS Testing**

- 10-Second Test
- Deep Battery Test for  minute(s)
- Test Until Battery Low
- Cancel Test

**Miscellaneous**

- Turn off UPS when AC power Fails
- Put UPS in Sleep mode for  minute(s)
- Wake up UPS
- Reboot UPS
- UPS Buzzer On/Off

At the bottom right of the interface, there are three buttons: "Apply", "Reset", and "Help".

Fig.21 Remote Control

## 2.1.5 Meter/Chart

This page displays temperature, capacity, load, voltage..etc of the UPS by appearing with meters/chart diagram.

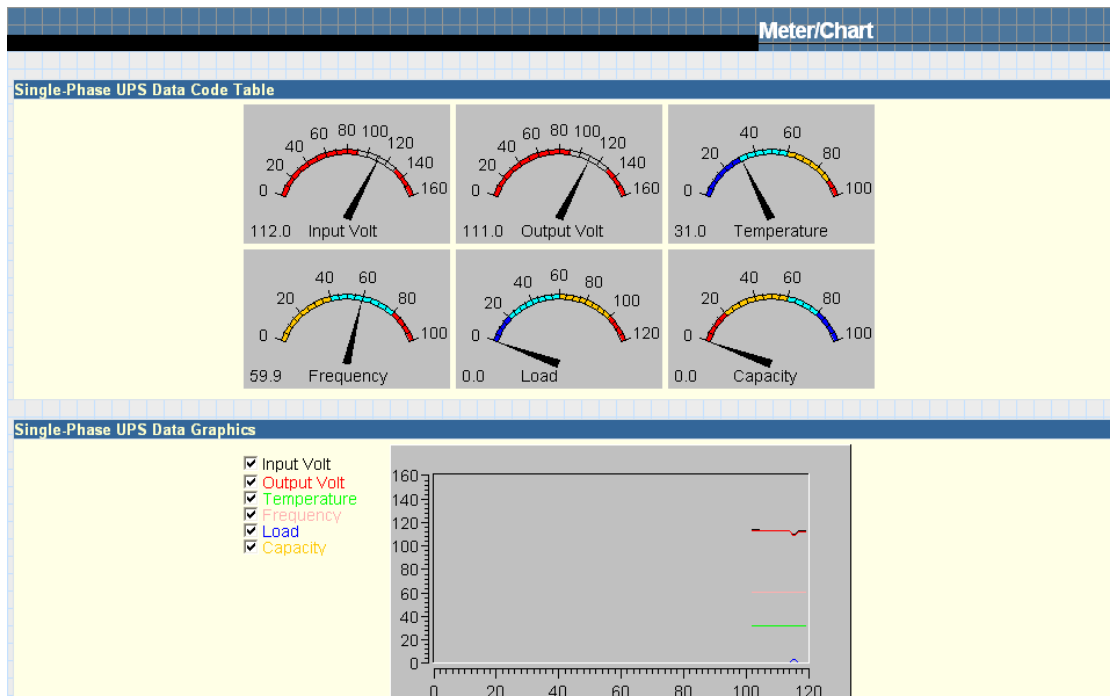

Fig.22 Meter/Chart

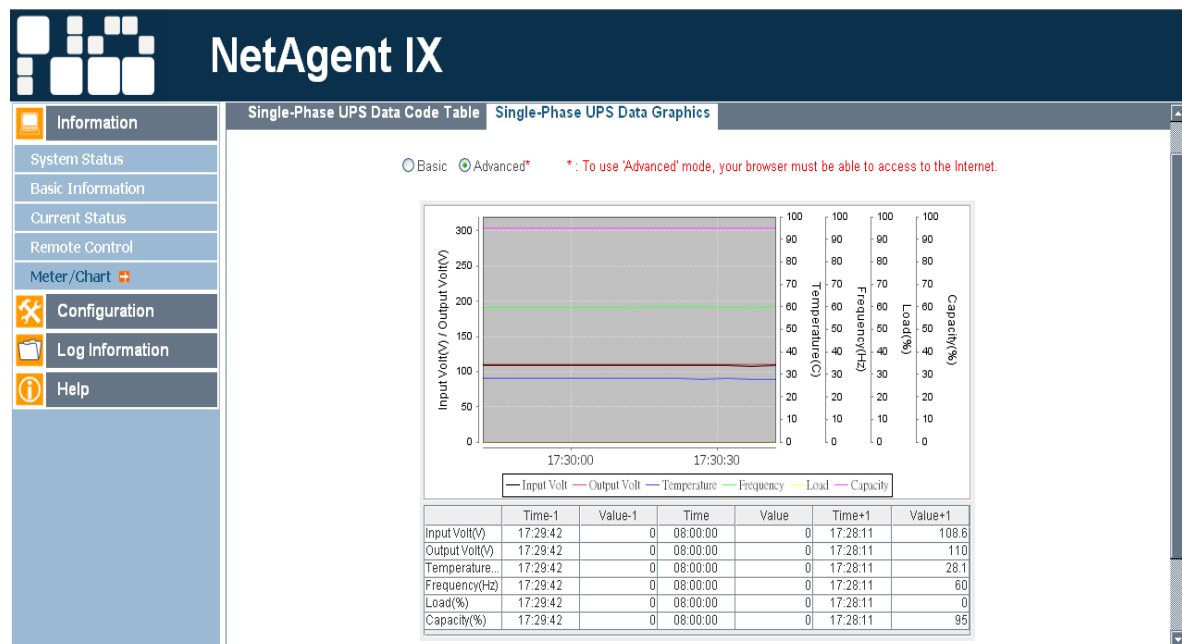

Fig 23. NetAgent 9 Meter/Chart

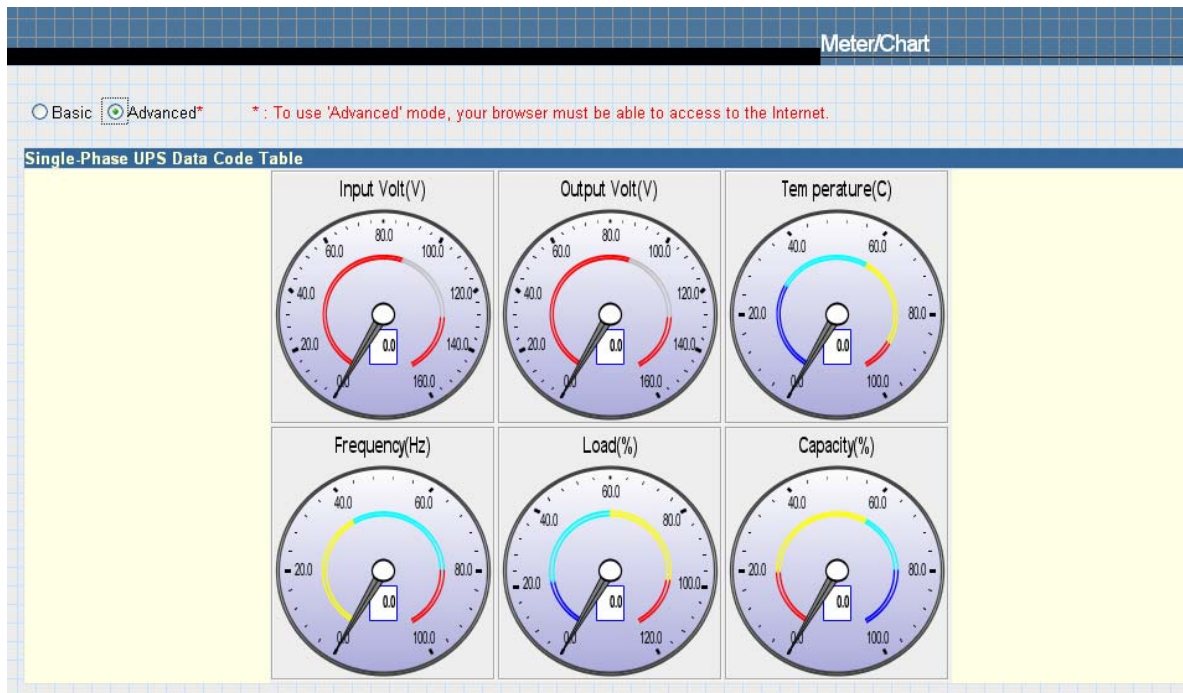

Fig.24 NetAgent 9 Meter/Chart

### 2.1.6 Modem Status (For 3 Ports NetAgent II only)

This page displays Modem's status and information. when 3 ports NetAgent II connects with modem.

#### Modem Information

This section displays the modem information.

#### GSM Modem Operating Status

This section displays the operating status between NetAgent and Modem.

Modem Status	
<b>Modem Information</b>	
Modem Manufacturer	SIEMENS
Modem Model	TC35i
Modem Firmware Version	REVISION 02.07
<b>GSM Modem Current Status</b>	
Service Provider	
Central number of SMS service	
Signal Strength	96%
SIM card PIN is correct or not	No SIM card detected

Fig.25 Modem Status

## 2.1.7 Environment Sensors-NetFeeler II

3 Ports NetAgent could be connected to NetFeeler II to detect the environmental status. NetFeeler II is to detect Temperature , Humidity and Water. It can receive signals from wireless smoke sensors, gas sensors and security sensors to detect further environmental conditions.

This page is to show details of the environment detected by NetFeeler II. Users could choose an interval from the drop-down box to refresh the status. All settings can be set in the Configuration/NetFeeler II page. The status will be displayed in red when NetFeeler II detects an abnormal status condition. In addition, NetFeeler II will also set off an alarm for notification.

### NetFeeler II Status

#### **Environmental Temperature**

This section is to show current temperature which is detected by NetFeeler II.

#### **Environment Humidity**

This section is to show current humidity which is detected by NetFeeler II.(shown as%)

#### **Water Status**

This section is to show water presence (ie. flood)which is detected by NetFeeler II.

#### **Gas Status**

This section is to show gas presence which detected by gas sensor. When leakage of gas detected, sensor would beep and stops only when gas vanish.

#### **Smoke Status**

This section is to show smoke presence (ie. fire) which is detected by smoke sensors.

#### **Security Status (Security1 ~ Security7)**

This section is to show open/close status for doors and windows. One NetFeeler II could monitor up to 7 Security Sensors.

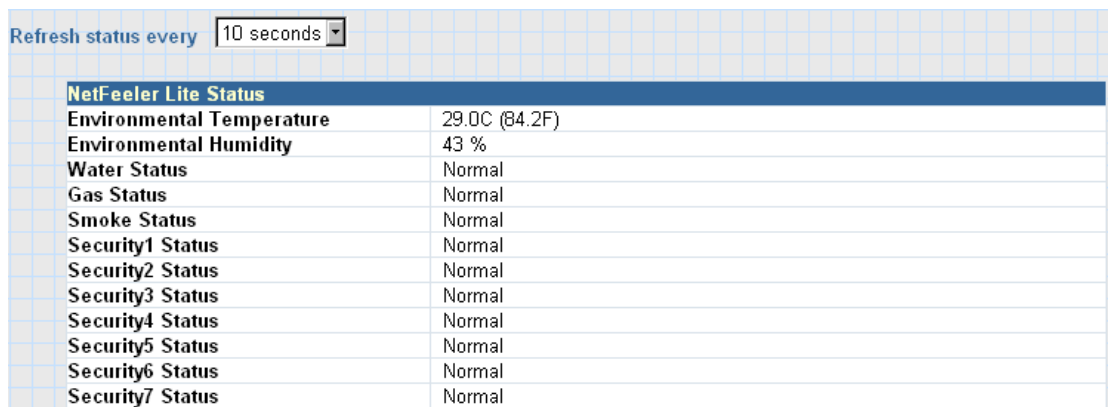

Refresh status every 10 seconds

NetFeeler Lite Status	
Environmental Temperature	29.0C (84.2F)
Environmental Humidity	43 %
Water Status	Normal
Gas Status	Normal
Smoke Status	Normal
Security1 Status	Normal
Security2 Status	Normal
Security3 Status	Normal
Security4 Status	Normal
Security5 Status	Normal
Security6 Status	Normal
Security7 Status	Normal

Fig.26 Environment Sensors - NetFeeler II

## **2.2 Configuration**

### **Sub-Menu :**

- 2.2.1 UPS Configuration**
- 2.2.2 UPS On/Off Schedule**
- 2.2.3 Network**
- 2.2.4 SNMP**
- 2.2.5 Email**
- 2.2.6 SMS**
- 2.2.7 Modem Port**
- 2.2.8 NetFeeler II**
- 2.2.9 NetSwitch Action (Apply on BT Model)**
- 2.2.10 WEB/Telnet**
- 2.2.11 System Time**
- 2.2.12 Language**

Please set each parameter correctly, so that NetAgent would operates properly.

Note: This page's selection would differ according to the different interface of the UPS.

## **2.2.1 UPS Configuration**

This page is to set the UPS configuration. Any wrong settings will cause incorrect display values or disconnection between the UPS and NetAgent.

### **UPS Properties**

#### **UPS Communication Type**

This section is to set up the communication interface of the UPS. (eg. Contact Closure/Megatec/Phoenixtec/ Megatec 3 phase etc.) Please refer to the UPS manual to set the correct communication type. Any wrong settings will cause disconnection between the UPS and NetAgent.

#### **Number of Batteries, Battery Full Charge Voltage (V), Battery Exhausted Charge Voltage (V)**

Please refer to the UPS manual to set the value.

#### **Date of last battery replacement (yyyy/mm/dd)**

This section is to record the date when the UPS battery was last replaced.

### **UPS Recorded**

#### **UPS Data Log**

This section is to set how often the UPS data should be logged.

### **Test UPS**

#### **Test UPS for every**

This section is to schedule the UPS to test once a week or once every two weeks or not to test

#### **Test UPS on Weekday**

This section is to set the UPS to test on a particular day of a week.

#### **Start Time of UPS Test ( hh:mm)**

This section is to set the UPS to test at a specific time on the test day.

#### **UPS Test Type**

This is to select which test to perform.

### **Warning Threshold Value**

#### **Time out of after lost of connection**

This section is to set a period of time after which NetAgent will send a disconnection warning message. This warning message will be sent after NetAgent has lost contact with the UPS for the time specified.

#### **Critical Loading (%)**

This section is to set the UPS critical loading. (shown as %) NetAgent will send a warning message when the UPS is overloaded.

#### **Critical Temperature (C)**

This section is to set the UPS critical internal temperature. NetAgent will send warning messages when the UPS overheats.

### Critical Capacity (%)

This section is to set the UPS critical battery capacity (shown as %) NetAgent will send warning messages when UPS low battery occurs.

UPS Configuration	
<b>UPS Properties</b>	
UPS Communication Type	MegaTec
Number of Batteries	2
Battery Full Charge Voltage (V)	2.267
Battery Exhausted Charge Voltage (V)	1.667
Date of last battery replacement (yyyy/mm/dd)	
<b>UPS Recorded</b>	
UPS Data Log	1 minute
<b>Test UPS</b>	
Test UPS every	None
Test UPS on Weekday	Monday
Start Time of UPS Test (hh:mm)	
UPS Test Type	10-Second Test 10 minute(s)
<b>Warning Threshold Value</b>	
Time out after loss of connection	30 seconds
Critical Load (%)	80
Critical Temperature (°C)	70.0
Critical Capacity (%)	10

Apply Reset Help

Fig.27 UPS Configuration



## 2.2.2 UPS On/Off Schedule

This page is to schedule On/Off time for the UPS and Wake On Lan.

### Weekly Schedule

This section is to set the time to turn on/off the UPS each day in the week.

### Date Schedule

This section is to set the time to turn on/off the UPS on particular days. (Eg, holidays.) The settings here override the settings in **Weekly Schedule**.

### Warning will be initiated before Schedule shutdown event

NetAgent will send a warning message before a scheduled shutdown. This section sets the delay time period after the message is sent and before the scheduled shutdown is started.

### Wake On LAN

This section is to wake the PC within the network. (Make sure the PC has such function supported and configure as "Enabled" under BIOS.) Enter the IP address of that PC and system would search its IP accordingly.

UPS On/Off Schedule			
<b>Weekly Schedule</b>			
		Turn On (hh:mm)	Turn Off (hh:mm)
Sunday		<input type="text"/>	<input type="text"/>
Monday		<input type="text"/>	<input type="text"/>
Tuesday		<input type="text"/>	<input type="text"/>
Wednesday		<input type="text"/>	<input type="text"/>
Thursday		<input type="text"/>	<input type="text"/>
Friday		<input type="text"/>	<input type="text"/>
Saturday		<input type="text"/>	<input type="text"/>
<b>Date Schedule</b>			
	Date (yyyy/mm/dd)	Turn On (hh:mm)	Turn Off (hh:mm)
	<input type="text"/>	<input type="text"/>	<input type="text"/>
	<input type="text"/>	<input type="text"/>	<input type="text"/>
	<input type="text"/>	<input type="text"/>	<input type="text"/>
	<input type="text"/>	<input type="text"/>	<input type="text"/>
	<input type="text"/>	<input type="text"/>	<input type="text"/>
Warning will be initiated <input type="text" value="10 minutes"/> before Scheduled Shutdown Event			
<b>Wake On Lan</b>			
Host1	IP: <input type="text"/>	MAC: <input type="text"/>	<input type="button" value="Test"/>
Host2	IP: <input type="text"/>	MAC: <input type="text"/>	<input type="button" value="Test"/>
Host3	IP: <input type="text"/>	MAC: <input type="text"/>	<input type="button" value="Test"/>
Host4	IP: <input type="text"/>	MAC: <input type="text"/>	<input type="button" value="Test"/>
Host5	IP: <input type="text"/>	MAC: <input type="text"/>	<input type="button" value="Test"/>
Host6	IP: <input type="text"/>	MAC: <input type="text"/>	<input type="button" value="Test"/>
Host7	IP: <input type="text"/>	MAC: <input type="text"/>	<input type="button" value="Test"/>
Host8	IP: <input type="text"/>	MAC: <input type="text"/>	<input type="button" value="Test"/>
			<input type="button" value="Apply"/> <input type="button" value="Reset"/> <input type="button" value="Help"/>

Fig.28 UPS On/Off Schedule

## 2.2.3 Network

This page is to set NetAgent Network settings.

### IP Address

#### **IP Address**

This section is to set NetAgent IP address.

#### **Subnet Mask**

This section is to set NetAgent Subnet Mask.

#### **Gateway**

This section is to set NetAgent Gateway.

#### **Obtain an IP address**

This section is to choose to set NetAgent IP address manually or via DHCP.

The above 4 sections can be set in Netility as well. NetAgent will reboot after any of the above are changed.

### DNS Server IP

#### **Primary DNS Server IP**

This section is to set NetAgent primary DNS Server IP address.

#### **Secondary DNS Server IP**

This section is to set NetAgent secondary DNS Server IP address. NetAgent will use the secondary DNS Server IP address when the Primary DNS Server IP address is not working.

### Ethernet

#### **Connection Type**

This section is to set communication speed between NetAgent and Network.

NetAgent will reboot after Connection Type is changed.

#### **Stop UPS communication when Ethernet disconnected**

This section is to set if to stop UPS communication when NetAgent disconnects with Ethernet

### Dynamic DNS

This is a free service that allows the user to alias a dynamic IP address to a static hostname

#### **Sevices Provider**

NetAgent can be configured to register with any of the Dynamic DNS providers.

In general, to register a Domain Name;

- a. Go to the DDNS provider website listed .
- b. Register a new user account and password with the DDNS provider.
- c. Choose a Domain Name to point to your current Dynamic IP
- d. Enter information obtained in (b) and (c) into NetAgent DDNS fields

**Domain Name**

This is the Domain Name you have created from the above selected DDNS provider.

**Login Name**

This is the Login / Account name that you have created with the selected DDNS provider.

**Login Password**

Enter the Password you have assigned to your DDNS Account.

**Use external STUN server to get Public IP to register**

Choose **Yes** to ensure that NetAgent uses the WAN / Public IP to update the selected DDNS server.

**PPPoE**

Use this option to allow NetAgent to connect to the Internet directly using your xDSL modem. Once set-up, NetAgent will connect directly to the Internet without going through a router. The LCD will display the current WAN / Public IP instead of the LAN IP Address.

**When Connection should be made**

This is to set if use PPPoE to connect with NetAgent UPS

- Disabled : Default setting.
- Connect always : NetAgent will automatically dial up and maintain continuous connection.

**Login Name**

Enter the login name assigned by your ISP.

**Login Password**

Enter the password assigned by your ISP.

Note : System will reboot if any configuration applies

Network	
<b>IP Address</b>	
IP Address	192.168.0.185
Subnet Mask	255.255.255.0
Gateway	192.168.0.1
Obtain an IP address*	Using DHCP
<b>DNS Server IP</b>	
Primary DNS Server IP	168.95.1.1
Secondary DNS Server IP	168.95.192.1
<b>Ethernet</b>	
Connection Type*	Auto Sense
Stop UPS communication when Ethernet disconnected	No
<b>Dynamic DNS</b>	
Services Provider	None
Domain Name	
Login Name	
Login Password	
Use external STUN server to get Public IP to register	Yes
Primary STUN Server IP	211.21.67.53
Secondary STUN Server IP	
<b>PPPoE</b>	
When Connection should be made	Disabled
Login Name	
Login Password	
* : System will reboot when these items have been Applied.	
<input type="button" value="Apply"/> <input type="button" value="Reset"/> <input type="button" value="Help"/>	

Fig.29 Network

## 2.2.4. Wireless

This is to configure Wireless network with USB wireless dongle. This feature only apply to NetAgent 9 model of BX series. (USB wireless dongle is optional)

NetAgent 9 BX models supports wireless encryption of Open system; Shared Key; WEP(64 /128 bit) / WPA / WPA2(TKIP/AES)

Following is the wireless configuration. (Setup was done under Lan network)

Click on Configuration → Wireless → Search AP and select the wireless SSID station and click on Select.

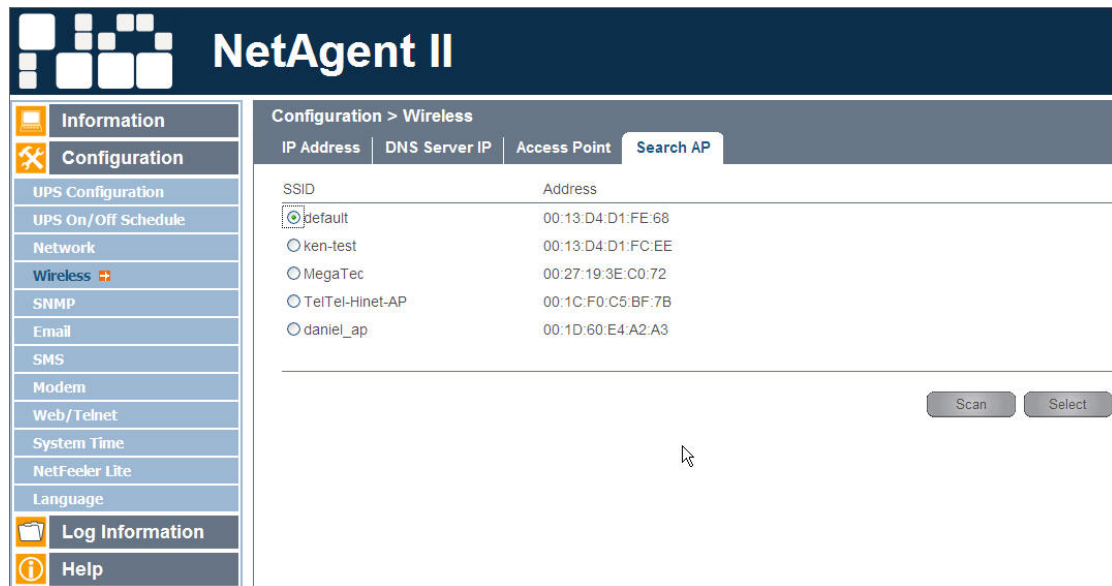

Fig.30 NetAgent 9 Wireless

Click on access Point → enter the encryption configuration and password then click on Apply



Fig 31. NetAgent 9 Wireless

Click on information→System Status, under Wireless Status, it displays the IP address of the wireless network



Fig.32 NetAgent 9 Wireles

## 2.2.5 SNMP

This page is to set NetAgent SNMP settings so it can be used by a NMS ( Network Management System). (Eg: SNMPView, SNMPView can be found on the NetAgent Utility CD.)

### MIB System

#### **System Name**

This section is to give a name to a NetAgent.

#### **System Contact**

This section is to give a name to the administrator.

#### **System Location**

This section is to set NetAgent location.

### Access Control

#### **Manager IP Address**

This section is to set the IP address that the administrator can manage NetAgent from. It is valid for up to 8 IP addresses. To manage NetAgent from any IP address, enter \*.\*.\* into **Manager IP address**.

#### **Version**

This is to select between SNMPv1& SNMPv2 or SNMPv3 (SNMPv3 only applies to NetAgent 9 series)

#### **Community**

This section is to set a Community name for NMS. The community name has to be as the same as the setting in NMS.

#### **Permission**

This section is to set authorities of administrators. Options are Read, Read/Write, and No Access.

#### **Username/password**

When select SNMPv3, username/password must be entered. Password must be at least 8 characters. Sender and Recipient's password must match to communicate.

#### **Authentication**

This is to select between MD5 and SHA. Length must be at least 8 characters.

#### **Privacy**

This is to select DES and AES. Length must be at least 8 characters.

**Description**

This section is for an administrator to make notes.

**Trap Notification****Receiver IP Address**

This section is to set receivers IP address for receiving traps sent by NetAgent. It is valid for up to 8 IP Addresses.

**Community**

This section is to set a Community name for NMS. The community name has to be as the same as the setting in NMS.

**Trap Type**

This section is to select if send trap according to PPC MIB or RFC1628

**Severity**

This section is to set Trap receiver levels. There are three levels of Trap receiver :

- Information: To receive all traps.
- Warning: To receive only “warning” and “severe” traps.
- Severe: To receive only “severe” traps.  
( Please refer to NMS manual for Trap levels.)

**Accept**

This section is to set to receive a trap or not.

**Description**

This section is for an administrator to make notes.

**Event**

This section is to select events for NetAgent to send traps. Clicking on Select will open a Select Events List. Or, Click on Test is to send test trap. Event Traps may be selected from this list. Events list is below:

<b>UPS Events</b>	<b>Yes</b>	<b>No</b>
Schedule Shutdown Event	<input checked="" type="radio"/>	<input type="radio"/>
UPS Failure	<input checked="" type="radio"/>	<input type="radio"/>
UPS entering Test mode	<input checked="" type="radio"/>	<input type="radio"/>
UPS entering Sleeping mode	<input checked="" type="radio"/>	<input type="radio"/>
UPS entering Boost mode	<input checked="" type="radio"/>	<input type="radio"/>
UPS Load Overrun	<input checked="" type="radio"/>	<input type="radio"/>
UPS Communication Lost	<input checked="" type="radio"/>	<input type="radio"/>
Turn Off UPS	<input checked="" type="radio"/>	<input type="radio"/>
AC Power Failed	<input checked="" type="radio"/>	<input type="radio"/>
UPS Battery Low	<input checked="" type="radio"/>	<input type="radio"/>
UPS Temperature Overrun	<input checked="" type="radio"/>	<input type="radio"/>
UPS Capacity Underrun	<input checked="" type="radio"/>	<input type="radio"/>
UPS entering Bypass mode	<input checked="" type="radio"/>	<input type="radio"/>
<b>NetFeeler Lite</b>	<b>Yes</b>	<b>No</b>
Smoke Alarm	<input checked="" type="radio"/>	<input type="radio"/>
Water Alarm	<input checked="" type="radio"/>	<input type="radio"/>
Gas Alarm	<input checked="" type="radio"/>	<input type="radio"/>
Security Alarm	<input checked="" type="radio"/>	<input type="radio"/>
Environmental Temperature Overrun	<input checked="" type="radio"/>	<input type="radio"/>
Environmental Temperature Underrun	<input checked="" type="radio"/>	<input type="radio"/>
Environmental Humidity Overrun	<input checked="" type="radio"/>	<input type="radio"/>
Environmental Humidity Underrun	<input checked="" type="radio"/>	<input type="radio"/>

Fig.33 UPS Events



## Device Connected

This section is to set the usage power and connection status of other devices which connects to the same UPS as NetAgent uses.

## SNMP UDP

This is to configure the UDP port of the NetAgent and trap receiver. SNMP default port is 161; and Trap MIB is UDP162

SNMP						
<b>MIB System</b>						
System Name		System Contact		System Location		
UPS Agent		Administrator		My Office		
<b>Access Control</b>						
Manager IP Address	Community	Permission	Description			
****	public	Read/Write				
****	public	No Access				
****	public	No Access				
****	public	No Access				
****	public	No Access				
****	public	No Access				
****	public	No Access				
****	public	No Access				
<b>Trap Notification</b>						
Destination IP Address	Community	Trap Type	Severity	Accept	Description	Events
	public	PPC	Information	No		Select Test
	public	PPC	Information	No		Select Test
	public	PPC	Information	No		Select Test
	public	PPC	Information	No		Select Test
	public	PPC	Information	No		Select Test
	public	PPC	Information	No		Select Test
	public	PPC	Information	No		Select Test
	public	PPC	Information	No		Select Test
<b>Device Connected</b>						
Device	Rating (%)	Connected				
	0	NO				
	0	NO				
	0	NO				
	0	NO				
<b>SNMP UDP Port</b>						
NetAgent SNMP Port*			Trap Receive Port			
161			162			
*: System will reboot when this item has been Applied.						
Apply Reset Help						

Fig.34 SNMP

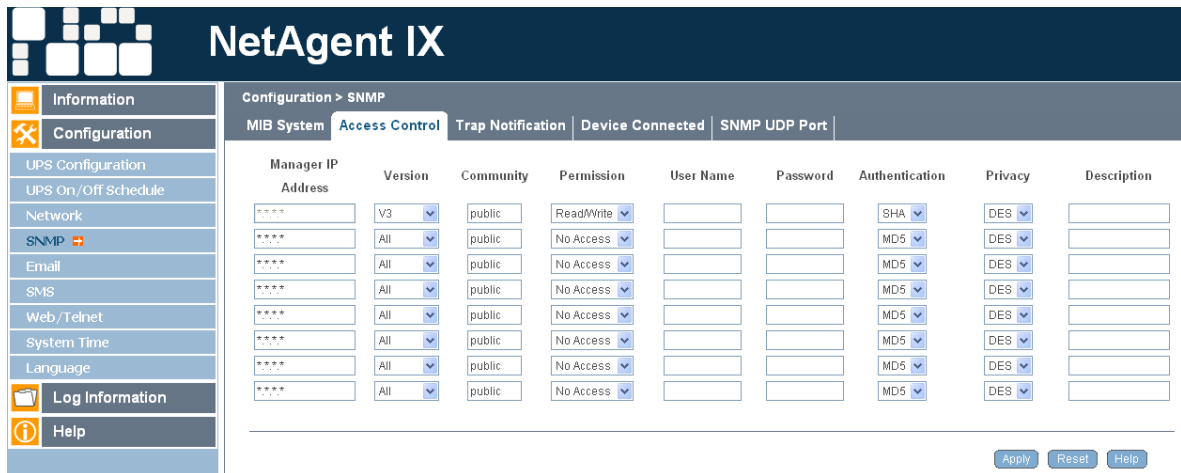

Fig 35. NetAgent 9 SNMP

## 2.2.6 Email

This page is to set Email details for use by NetAgent.

NetAgent CP, DP series only support SMTP

NetAgent BT, CT, DT series and NetAgent 9 series of BX, CX, DX supports SMTP and SSL SMTP.

### Email Setting

Email Server This section is to set NetAgent Email Server . Note that free email server such as Hotmail, yahoo, Gmail is not allowed

### **Email Port**

This is to configure the SMTP port to send email

### **Sender's Email Address**

This section is to set NetAgent's Email address.

### **Email Server Requires Authentication**

This section is to set whether the Email Server requires authentication.

### **Account Name**

This section is to set an Email account name when the email server requires authentication.

### **Password**

This section is to set a password when the email server requires authentication.

### **Sending test mail**

This is to send a test mail by clicking on Test Mail to the mail address configured

### **Recipient's Email Address (for Event Log)**

This section is to set Email Addresses to receive warning email sent by NetAgent when an event occurs. It is valid for up to 8 Email addresses.

### **Send Email When Event Occurs**

This section is to set NetAgent to send warning Email when an event occurs.

### **Account 1~8**

8 email addresses could be configure with selected event

## Event

This section is to select events for NetAgent to send warning email. Clicking on Select will open a Select Events List. Event email may be selected from this list. (The list is the same as under SNMP setting. Please refer to page 35, figure 31)

## Recipient's Email Address (for Daily Report)

This section is to set Email Addresses to receive Daily Report email sent by NetAgent when an event occurs. It is valid for up to 4 Email addresses.

## Send Email for Daily Report ( hh:mm)

This section is to set a particular time for NetAgent to send Daily Report every day.

## Send email when Event Log overflows (500 records)

Select **YES** to have NetAgent send a warning email stating Event Log has reached 500. The data will now be purged to make room for new data.

## Send email when Data Log overflows (500 records)

Select **YES** to have NetAgent send a warning email stating Data Log has reached 500. The data will now be purged to make room for new data.

The screenshot shows the 'Email' configuration page. It is divided into several sections:

- Email Setting:** Fields for Email Server, Email Port (25), Sender's Email Address, Email Server Requires Authentication (NO), Account Name, Password, and Sending test mail (with a Test Mail button).
- Recipient's Email Address (for Event Log):** A table with columns for Account (Account1-8), Email Address, and Events (Select button).
- Recipient's Email Address (for Daily Report):** Fields for Account1-4, Email Address, and Send Email for Daily Report (hh:mm) (NO at 12:00).
- Send Email when Event Log overflows (500 records):** NO
- Send Email when Data Log overflows (500 records):** NO

Buttons for Apply, Reset, and Help are located at the bottom right.

Fig.36 Email

## 2.2.7 SMS

When UPS events occurs, it allows Short Message Signals (“SMS”) to be sent and received using a GSM/GPRS/CDMA Modem. Operation information are as below for single and three ports of NetAgent.

### 2.2.6.1 To send SMS by single port of NetAgent

It requires to use remote “SMSAgent” or freeware SMS Server

#### SMS Settings

##### Send SMS when Event Occurs

This section is to select if use local modem or remote service to send SMS. Select local modem when modem connects with 3 Ports NetAgent. Select remote service if modem connects to PC using SMS Server software or connects with SMSAgent. Select Disable if not needed.

##### SMS Server, SMS Server Port

This section is to set the IP address of the SMSAgent or PC if selected remote service. (e.g. 192.168.0.180) and Port Number (default:80)

##### Account Name, Password

This section is to enter SMSAgent’s account and password if configured (SMSAgent webpage→ Configuration→Web/Telnet). Leave blank if no such setting

##### Receiver cellular number (for Event Log)

This section is to set the recipient’s mobile number. A total of 8 mobile numbers can be assign. (Selectable events list is same as SNMP webpage. Refer to page 35, figure 31 :UPS Event)

Note: 1) Enter mobile number same as sending from mobile.  
Note: 2) Please refer to SMSAgent’s user manual for further information.  
Note: 3) See Appendix for further information

SMS Settings		
Send SMS When Event Occurs	Disable	
SMS Server	192.168.0.1	
SMS Server Port	80	
Account Name		
Password		
Sending test SMS		Test SMS

Receiver cellular number(for Event Log)			Events
Cellular Phone number 1			Select
Cellular Phone number 2			Select
Cellular Phone number 3			Select
Cellular Phone number 4			Select
Cellular Phone number 5			Select
Cellular Phone number 6			Select
Cellular Phone number 7			Select
Cellular Phone number 8			Select

Apply Reset Help

Fig 37. SMS



Fig 38. NetAgent 9 SMS

## 2.2.8 Modem (For 3 Ports NetAgent II only)

This section is to configure Modem's setting if 3 ports NetAgent connects with GSM/GPRS Modem.

### Modem Setting

#### Modem Communication Interface

##### Communication Type

##### Suitable Condition

#### SMS

When NetAgent connects with Megatec's GSM/GPRS Modem

#### PPP Dial-in

When NetAgent connects with dial in modem

#### NetSwitch

When NetAgent connects with BT NetAgent

### SMS Setting

#### SMS Communication

##### Communication Type

##### Suitable Condition

#### GPRS

To use with GSM 900/1800 or GPRS 900/1800/1900 frequency, and make sure the local telecom supports such service

#### CDMA

To use with GSM 800/900/1800 frequency, and make sure the local telecom supports such service

#### SIM Card PIN

Enter the SIM password

#### Confirm SIM Card PIN

SIM Password must match the one set above.

### Receiver cellular number and message content

To send instant SMS, enter recipient's mobile number and SMS text with configurable of Unicode or Character format

### NetSwitch (BT series only)

When BT NetAgent connects with NetSwitch on RPM, it able to perform action to the specific outlet when following event or alarm triggers.

## Events

1. UPS Load Overrun	2. UPS Communication Lost	3. AC Power Failed
4. UPS Battery Low	5. UPS Temperature Overrun	6. When battery capacity reaches to __%

## NetFeeler II (environmental sensor)

1. Temperature Overrun/ Underrun	2. Humidity Overrun/Underrun	3. Water
4. Smoke	5. Gas	6. Security (Door/ Windows 1~7)

## NetSwitch Setting

**Select NetSwitch:** To select the NetSwitch

**Address Change:** RPM could be daisy chain up to 16 units to control a total of 128 devices. Use this to assign a new number or change the currently assigned number for the RPM unit. You have a choice of 00 to 16.

**Note:** You cannot choose a number that is already assigned to another RPM.

**Identification:** To give a unique name for the RPM.

**Outlet:** Indicate outlets A-H

**Name:** To set a unique name for the Outlets

**Phone Controllable:** Option of "Yes" or "No"

**Control type:** Select between "Instant Shutdown"; "Safe Reboot"; "Safe Shutdown"

**Power off Delay:** Sets the power off delay time in seconds (value from 0 to 9999)

**Power Resume Delay:** Sets the power resume/on delay time in seconds (value from 0 to 9999)

The screenshot shows a web-based configuration interface for a modem. The title bar at the top right says "Modem". The interface is divided into several sections:

- Modem Settings:** A dropdown menu for "Modem Communication Type\*" is set to "SMS".
- SMS Settings:** A dropdown menu for "SMS Communication" is set to "GPRS". Below it are two empty text input fields for "SIM Card PIN" and "Confirm SIM Card PIN".
- Receiver cellular number and message content:** A text input field for "Cellular Phone number" and another for "SMS content (Max. length 70 characters)". To the right of the SMS content field are two radio buttons: "Unicode" (which is selected) and "Character".

At the bottom right of the interface, there are buttons for "Apply", "Reset", and "Help". A red asterisked note at the bottom left states: "\*Select 'PPP dial-in' in 'Modem communication' will restart the system."

Fig.39 Modem

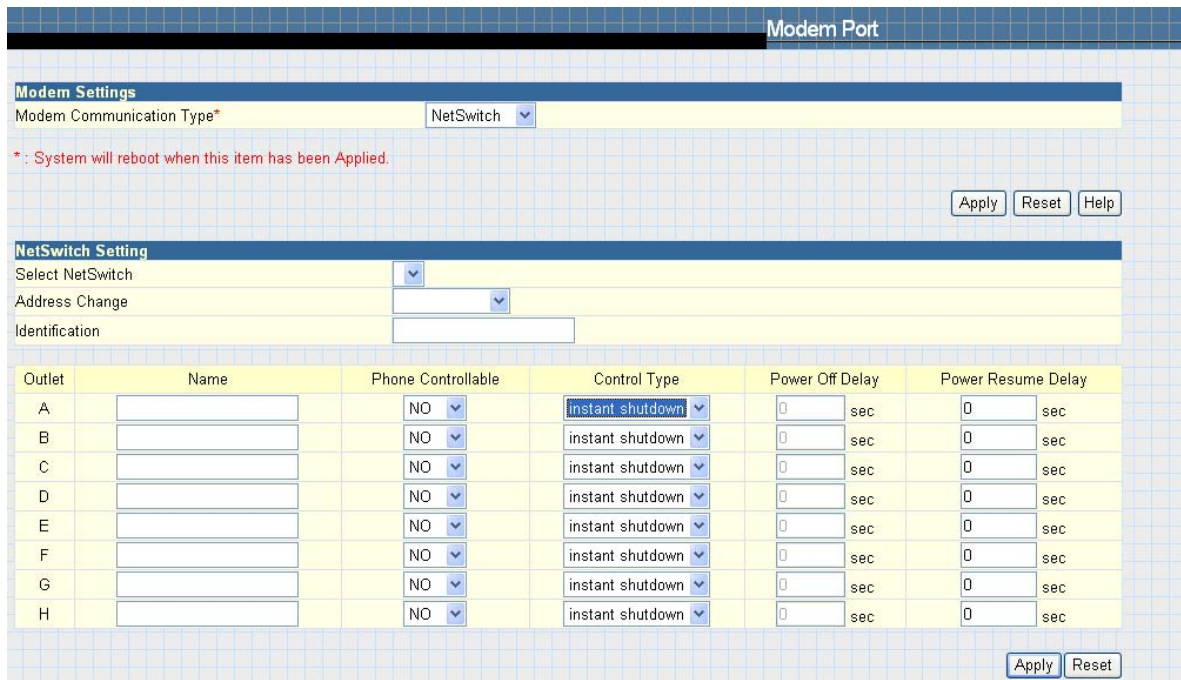

Fig 40. Modem Port with NetSwitch

### NetSwitch Status

When BT connects with NetAgent, this will appear under Information option.

This section allows remote control over the RPM unit and its individual devices. Click on the individual power input icon to either switch on / off the device.

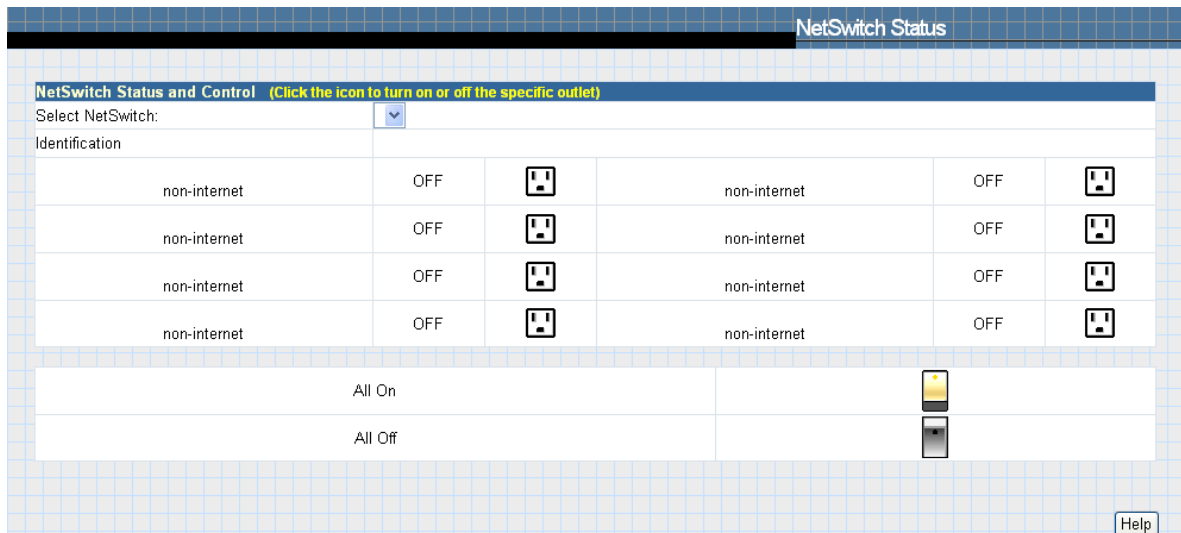

Fig.41 NetSwitch Status

## NetSwitch Action

This is to configure the action on specific event when occur. NetSwitch would executes the action per setting as to turn on or turn off on the assigned outlet.

Click on New to select event and set action.

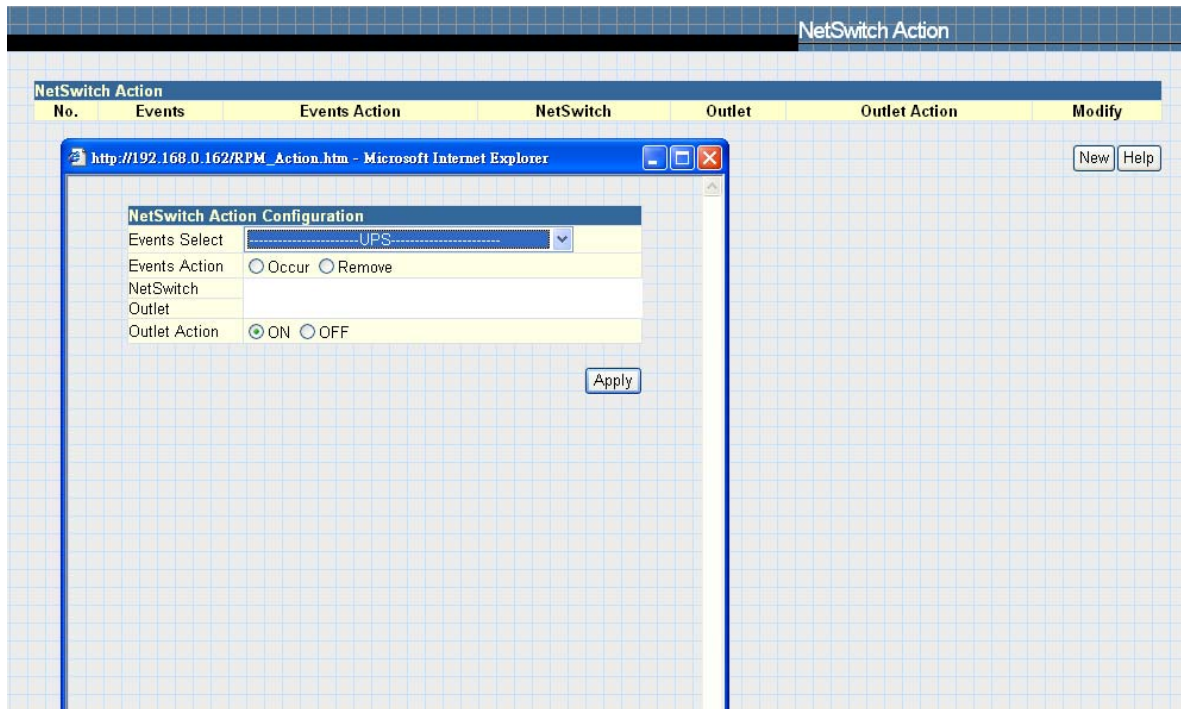

Fig:42. NetSwitch Action

## 2.2.9 WEB/Telnet

This page is to set up the User Account in NetAgent.

### User Account

#### **User Name**

This section is to set a user name for NetAgent web pages. It is valid for up to 8 users. Users have to input the user name to get access to NetAgent web pages from a web browser.

#### **Password**

This section is to set a password for NetAgent web pages. Users have to input the password to get access to NetAgent web pages from a browser.

#### **Permission**

This section is to set user's authorizations of Read, or Read/Write.

#### **IP Filter**

This section is to set a particular IP address. Users can only gain access to NetAgent web pages if they come from this IP address. If you want to manage NetAgent from any IP address, you can set it as \*.\*.\*.

### RADIUS Server Settings

This is to configure the parameter of the radius server. Please refer to the appropriate radius server setting

Only for NetAgent BT、CT、DT series and NetAgent 9 series of BX、CX、DX models



### Enable RADIUS in Web/Telnet login

To select between Yes or No

### RADIUS Server Address

To enter the IP address of the radius server

### Authentication Port

To enter the UDP communication port number

### Shared Key

This is to enter the password to login to radius server

### Connection Timeout

Set the timeout for completion of RADIUS requests

### Connection Retry

Set the number of retries for RADIUS requests.

### SSL Public Key Information

This is to upload the SSL public key.

Only for NetAgent BT、CT、DT series and NetAgent 9 series of BX、CX、DX models

### SSL Certificate Information

This is to upload the SSL certificate. When both public key and certificate are uploaded to NetAgent web server, the communication will be encrypted by SSL on the Internet by entering with Http:// on the browser.

(To communicate via Https, make sure to enable Https port 443. See page 19)

User Account			
User Name	Password	Permission	IP Filter
<input type="text"/>	<input type="text"/>	Read/Write	****
<input type="text"/>	<input type="text"/>	No Access	****
<input type="text"/>	<input type="text"/>	No Access	****
<input type="text"/>	<input type="text"/>	No Access	****
<input type="text"/>	<input type="text"/>	No Access	****
<input type="text"/>	<input type="text"/>	No Access	****
<input type="text"/>	<input type="text"/>	No Access	****
<input type="text"/>	<input type="text"/>	No Access	****

Auto LogOff after idle for  minute(s) (0: Disable)

RADIUS Server Settings	
Enable RADIUS in Web/Telnet login	NO
RADIUS Server Address	<input type="text"/>
Authentication Port	1812
Shared Key	<input type="text"/>
Connection TimeOut	5 second(s)
Connection Retry	3

Apply Reset Help

SSL Public Key Information	
SSL Public Key	<input type="text"/> 瀏覽... <span style="float: right;">Upload and Replace*</span>
Public Key Length	512 bits
SSL Certificate Information	
SSL Certificate	<input type="text"/> 瀏覽... <span style="float: right;">Upload and Replace*</span>
Issued To	NetAgent
Issued By	NetAgent
Valid From	2010-04-09
Valid Until	2011-04-09

\*: This upload function could not be used in HTTPS mode.

Fig.43 WEB/Telnet

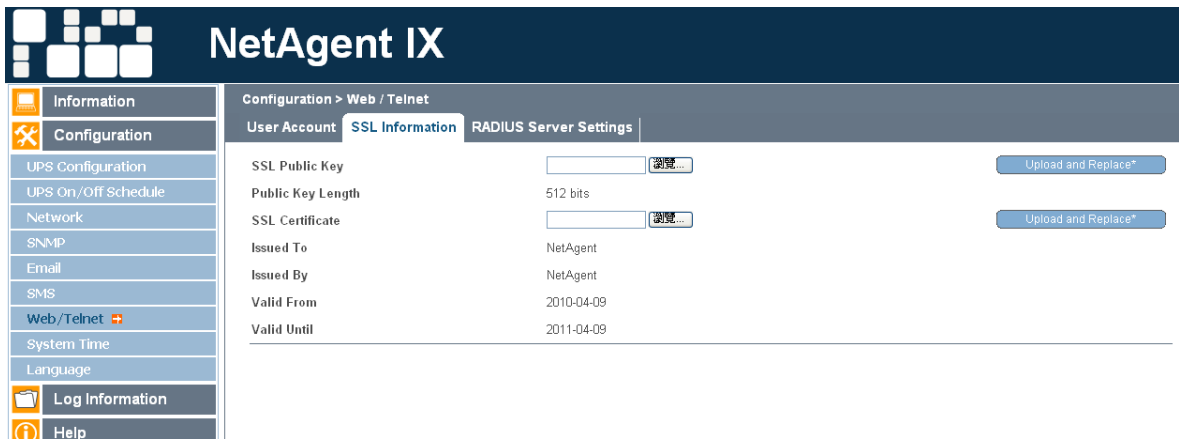

NetAgent IX Configuration > Web / Telnet

User Account | **SSL Information** | RADIUS Server Settings

SSL Public Key	<input type="text"/> 瀏覽...	<span>Upload and Replace*</span>
Public Key Length	512 bits	
SSL Certificate	<input type="text"/> 瀏覽...	<span>Upload and Replace*</span>
Issued To	NetAgent	
Issued By	NetAgent	
Valid From	2010-04-09	
Valid Until	2011-04-09	

Fig.44 NetAgent 9 SSL



NetAgent IX Configuration > Web / Telnet

User Account | SSL Information | **RADIUS Server Settings**

Enable RADIUS in Web/Telnet login	<input type="text" value="NO"/>
RADIUS Server Address	<input type="text"/>
Authentication Port	<input type="text" value="1812"/>
Shared Key	<input type="text"/>
Connection TimeOut	<input type="text" value="5"/> second(s)
Connection Retry	<input type="text" value="3"/>

Apply Reset Help

Fig.45 NetAgent 9 Radius

## 2.2.10 System Time

This page is to set NetAgent system time. You can provide NetAgent with up to 2 time servers or you can set a time zone.

### System Time

#### Time Between Automatic Updates

This section is to set an interval for time synchronization.

**Time Server**

Choose the nearest **Time Server** to your NetAgent location. The Administrator can choose from the list of a maximum of 30 Time Servers. If to add new time server, click on Edit and delete any time server from the list provided and add a new one .

**Time Zone (Relative to GMT)**

This section is to set a different time zone for different countries.

**Using Daylight Saving Time**

Choose between Yes or No

**System Time (yyyy/mm/dd hh:mm:ss)**

This section is to set NetAgent system time manually.

Set this in the format: yyyy/mm/dd hh:mm:ss

**Auto Restart****Auto Restart System for Every n Minute(s)**

Use this setting to auto restart the system at a predetermined interval. The default value is set to "0" (disabled). Enter between, 1 to 9999 Minute (i.e., between 1 minute or 166.65 hour) or 1 to 9999 Hour (1 hour to 416.6 days).

**Manual Restart System After 30 Seconds**

Use this feature to manually restart the system NetAgent restart in about 30 seconds.

**Backup Time**

This is to save the event log and data log automatically with the configured hour on external USB flash. This only applies on BX NetAgent models and the USB flash disk must be with FAT/FAT32 format

**Time Between Log Backup**

To configure the time in hour to save log file.

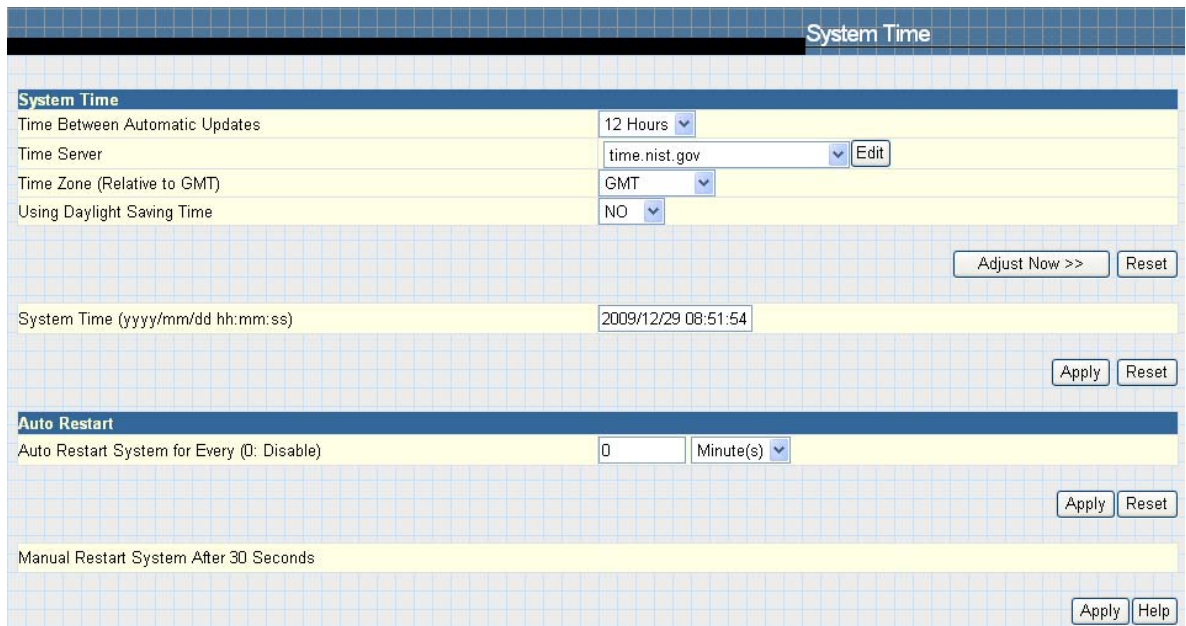

Fig.46 System Time

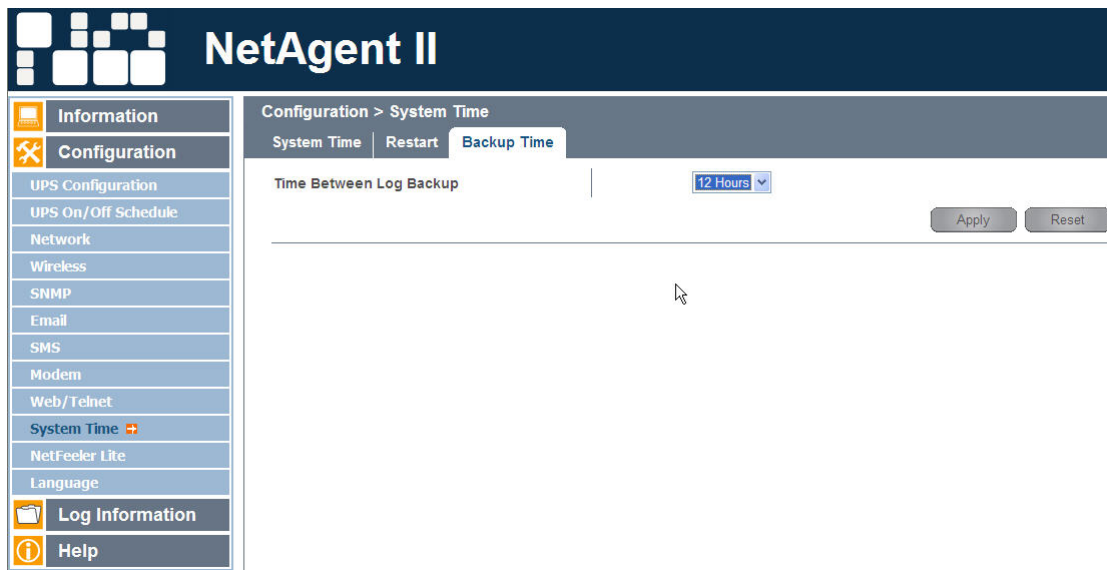

Fig.47 NetAgent 9 System Time

### 2.2.11 NetFeeler II (For 3 Ports NetAgent II only)

This page is to set Environmental sensors-NetFeeler II's configurations.

#### NetFeeler II

##### **Critical UnderRun**

This section is to set the lowest critical values for temperature and humidity. NetFeeler II will send a warning message when it detects temperature or humidity values below these settings.

### Critical OverRun

This section is to set the highest critical values for temperature and humidity. NetFeeler II will send a warning message when it detects temperature or humidity values above these settings.

### Security Label

NetFeeler II may connect up to 7 security sensors. This section is to set the location of searched sensor.

NetFeeler Lite		
	Critical UnderRun	Critical OverRun
Humidity (%)	<input type="text" value="5"/>	<input type="text" value="90"/>
Temperature (C)	<input type="text" value="5.0"/>	<input type="text" value="70.0"/>

Security Label		
Label 1	<input type="text" value="Security1 Status"/>	
Label 2	<input type="text" value="Security2 Status"/>	
Label 3	<input type="text" value="Security3 Status"/>	
Label 4	<input type="text" value="Security4 Status"/>	
Label 5	<input type="text" value="Security5 Status"/>	
Label 6	<input type="text" value="Security6 Status"/>	
Label 7	<input type="text" value="Security7 Status"/>	

Fig.48 NetFeeler II

## 2.2.12 Language

This page is to set the language interface for NetAgent.

### Interface Language

This section is to set the language for NetAgent web pages. When users first start to open the webpage of NetAgent, NetAgent will auto detect the language in the computer system and show the same language on its web pages. Users can also choose the languages they prefer from the "Interface Language" list.

Note: Users will have to enable cookies before they use this function.

### Email Preferences

Select language preference when receive emails and SMS.



Fig.49 Language

NetAgent CP and DP's model divides the language firmware into two. EAST and WEST

East Firmware	English 、 Traditional Chinese 、 Simplified Chinese 、 Korean 、 Japanese 、 Russian 、 Thai
West Firmware	English 、 German 、 Portuguese 、 Spanish 、 French 、 Italian 、 Turkish 、 Russian

NetAgent CT, DT and BT supports the following languages

English 、 Traditional Chinese 、 Simplified Chinese 、 Korean 、 Japanese 、 Russian 、 Thai, German 、 Portuguese 、 Spanish 、 French 、 Italian 、 Turkish 、 Russian 、 Polish
--

NetAgent 9 CX, DX and BX supports the following languages

English 、 Traditional Chinese 、 Simplified Chinese 、 Korean 、 Japanese 、 Russian 、 Thai, German 、 Portuguese 、 Spanish 、 French 、 Italian 、 Turkish 、 Russian 、 Polish
--

## 2.3 Log Information

### Sub-Menu :

#### 2.3.1 Event Log

#### 2.3.2 SMS

#### 2.3.3 Data Log

#### 2.3.4 Save Data Log

NetAgent Log Record			
Log Information	Model		
	Single Port (DP,CP)	Single Port (DT,CT,CX,DX)	3Ports (BT,BX)
Event Log	100 logs	1000 logs	1000 logs
SMS Log	---	---	1000 logs
UPS data Log	500 logs	5000 logs	5000 logs

Fig.50 NetAgent Log Record

### 2.3.1 Event Log

This page is a UPS Event log. It shows a record of all events, giving the Date/Time of the event and a detailed description of each. When reach to the limit, it rewrites on the previous logs

#### **Date/Time**

This is a record of the Date ( yyyy/mm/dd ) and Time ( hh:mm:ss ) that the event occurred.

#### **Event**

This is a detailed description of the event.

#### **Save**

This is to save the event log

## Event Log

Date/Time	Event
2007/09/17 16:29:11	The TimeServer connection failed!
2007/09/17 13:22:30	The TimeServer connection failed!
2007/09/17 10:17:10	The TimeServer connection failed!
2007/09/17 07:16:31	The TimeServer connection failed!
2007/09/17 04:14:31	The TimeServer connection failed!
2007/09/17 01:13:11	The TimeServer connection failed!
2007/09/16 19:10:31	The TimeServer connection failed!
2007/09/16 16:09:51	The TimeServer connection failed!
2007/09/16 13:07:51	The TimeServer connection failed!
2007/09/16 07:05:52	The TimeServer connection failed!
2007/09/16 04:02:32	The TimeServer connection failed!
2007/09/16 01:01:52	The TimeServer connection failed!
2007/09/15 21:57:12	The TimeServer connection failed!
2007/09/15 18:47:12	The TimeServer connection failed!
2007/09/15 15:43:12	The TimeServer connection failed!
2007/09/15 12:41:52	The TimeServer connection failed!
2007/09/15 09:41:12	The TimeServer connection failed!
2007/09/15 06:39:53	The TimeServer connection failed!
2007/09/15 03:35:13	The TimeServer connection failed!
2007/09/15 00:33:13	The TimeServer connection failed!
2007/09/14 21:31:53	The TimeServer connection failed!
2007/09/14 18:27:13	The TimeServer connection failed!
2007/09/14 15:23:53	The TimeServer connection failed!
2007/09/14 06:22:33	The TimeServer connection failed!
2007/09/14 03:17:13	The TimeServer connection failed!
2007/09/14 00:08:33	The TimeServer connection failed!
2007/09/03 19:38:42	The TimeServer connection failed!
2007/09/03 16:38:02	The TimeServer connection failed!
2007/09/03 13:37:23	The TimeServer connection failed!
2007/09/03 10:35:23	The TimeServer connection failed!
2007/09/03 07:34:03	The TimeServer connection failed!

Clear Help

Fig.51 Event Log



### 2.3.2 SMS

This page is a SMS Event log. It shows a record of all mobile number, giving the Date/Time of the SMS sent and a detailed description of each. When reach to the limit, it rewrites on the previous logs

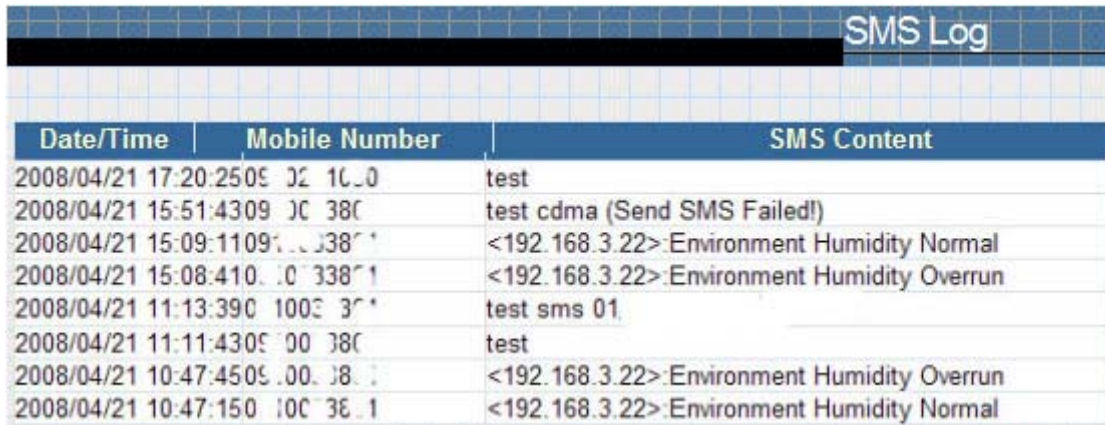

Date/Time	Mobile Number	SMS Content
2008/04/21 17:20:25	02 10 0	test
2008/04/21 15:51:43	0C 38C	test cdma (Send SMS Failed!)
2008/04/21 15:09:11	00 338	<192.168.3.22>:Environment Humidity Normal
2008/04/21 15:08:41	00 338	<192.168.3.22>:Environment Humidity Overrun
2008/04/21 11:13:39	100C 3	test sms 01
2008/04/21 11:11:43	00 38C	test
2008/04/21 10:47:45	00 38	<192.168.3.22>:Environment Humidity Overrun
2008/04/21 10:47:15	10C 3E 1	<192.168.3.22>:Environment Humidity Normal

Fig.52 SMS Log

### 2.3.3 Data Log

This page is a UPS data log. It records UPS Input Voltage/Output Voltage/Frequency/ Loading/Capacity/ Temperature. When reach to the limit, it rewrites on the previous logs. Logs can be saved in CSV format by clicking on “Save Data Log”.

#### **Date/Time**

This is a record of the Date (yyyy/mm/dd) and Time (hh:mm:ss) that the data was recorded. The interval between every log can be set in /Configuration/ UPS configuration/ UPS recorded/UPS data Log/.

#### **Input Volt.**

This section shows records of the UPS Input voltage readings. (Unit: Volt.)

#### **Output Volt.**

This section shows records of the UPS Output voltage readings. (Unit: Volt.)

#### **Freq. (Hz)**

This section shows records of the UPS Input Frequency. (Unit: Hertz)

#### **Load**

This section shows records of the UPS Output loading. (shown as %)

#### **Capacity**

This section shows records of the UPS battery capacity. (shown as %)

#### **Temp.**

This section shows records of the UPS internal temperature. (unit: degrees Centigrade)

#### **Env. Temp.**

This section shows environmental temperature which detected by NetFeeler II

#### **Env. Humidity**

This section shows environmental humidity which detected by NetFeeler II

Data Log							
Date/Time	Input Volt.	Output Volt.	Freq. (Hz)	Load	Capacity	Temp.	
2007/09/17 17:21:26	114.0	113.0	59.9	0	100	32.0C	89.6F
2007/09/17 17:20:25	114.0	114.0	59.8	0	100	32.0C	89.6F
2007/09/17 17:19:25	113.0	114.0	59.9	0	100	32.0C	89.6F
2007/09/17 17:18:24	114.0	115.0	59.9	0	100	32.0C	89.6F
2007/09/17 17:17:24	114.0	114.0	59.9	0	100	32.0C	89.6F
2007/09/17 17:16:23	115.0	114.0	59.9	0	100	32.0C	89.6F
2007/09/17 17:15:23	113.0	114.0	59.9	0	100	32.0C	89.6F
2007/09/17 17:14:22	114.0	114.0	59.9	0	100	32.0C	89.6F
2007/09/17 17:13:22	114.0	113.0	59.8	0	100	32.0C	89.6F
2007/09/17 17:12:21	114.0	114.0	59.9	0	100	32.0C	89.6F
2007/09/17 17:11:21	114.0	113.0	59.9	0	100	32.0C	89.6F
2007/09/17 17:10:20	114.0	115.0	59.8	0	100	32.0C	89.6F
2007/09/17 17:09:20	114.0	114.0	59.9	0	100	32.0C	89.6F
2007/09/17 17:08:19	114.0	115.0	59.9	0	100	32.0C	89.6F
2007/09/17 16:48:10	113.0	112.0	59.8	0	100	32.0C	89.6F
2007/09/17 16:47:09	113.0	112.0	59.9	0	100	32.0C	89.6F
2007/09/17 16:46:09	113.0	113.0	59.9	0	100	32.0C	89.6F
2007/09/17 16:45:08	113.0	113.0	59.9	0	100	32.0C	89.6F
2007/09/17 16:44:08	113.0	113.0	60.0	0	100	32.0C	89.6F
2007/09/17 16:43:07	113.0	113.0	59.8	0	100	32.0C	89.6F
2007/09/17 16:42:07	113.0	112.0	59.9	0	100	32.0C	89.6F
2007/09/17 16:41:06	113.0	113.0	59.8	0	100	32.0C	89.6F
2007/09/17 16:40:06	113.0	112.0	59.9	0	100	32.0C	89.6F
2007/09/17 16:39:05	113.0	114.0	59.9	0	100	32.0C	89.6F
2007/09/17 16:38:05	112.0	112.0	59.9	0	100	32.0C	89.6F
2007/09/17 16:37:04	112.0	112.0	59.9	0	100	32.0C	89.6F
2007/09/17 16:36:04	112.0	112.0	59.9	0	100	32.0C	89.6F
2007/09/17 16:35:03	113.0	113.0	59.8	0	100	32.0C	89.6F
2007/09/17 16:34:03	113.0	113.0	59.8	0	100	32.0C	89.6F
2007/09/17 16:33:03	113.0	112.0	59.9	0	100	32.0C	89.6F

Fig.53 Date Log

### 2.3.3 Save Data Log

This function is to record RS232 UPS's voltage, frequency, load, capacity, temperature..etc to save as another file for the other purpose to the manager.

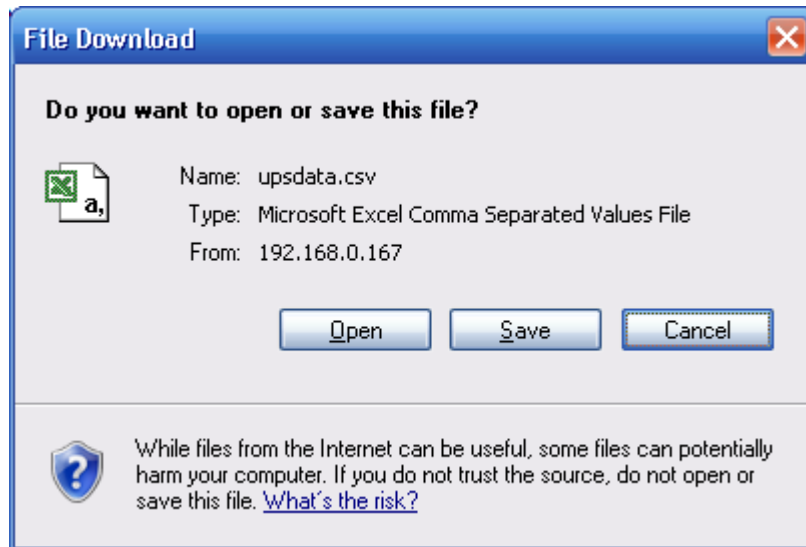

Fig.54 Save Data Log

## 2.4 Help

### Sub-Menu :

- 2.4.1 Search NetAgent
- 2.4.2 Serial Port Debug
- 2.4.3 Help
- 2.4.4 About

### 2.4.1 Search NetAgent

This to display all the found NetAgent within network with its serial number; Mac Address; Hardware/Firmware version and its IP address. Double clicking on the highlighted unit to open the webpage of such device.

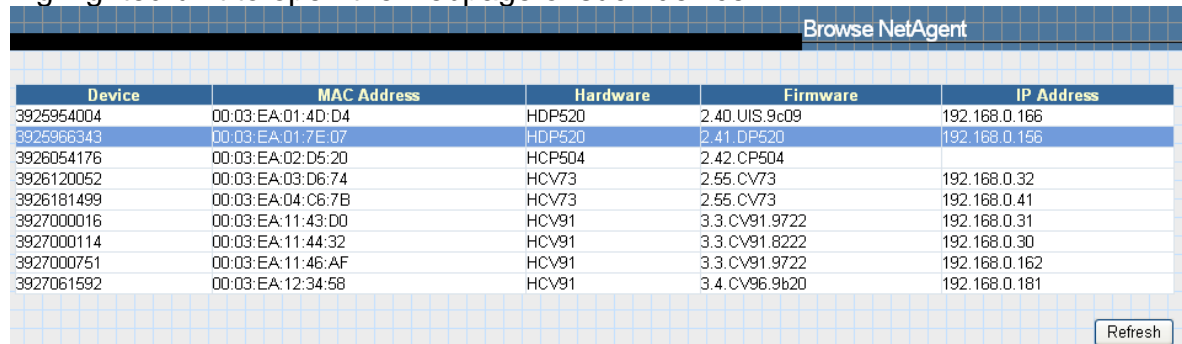

Device	MAC Address	Hardware	Firmware	IP Address
3925954004	00:03:EA:01:4D:D4	HDP520	2.40.UIS.9c09	192.168.0.166
3925966343	00:03:EA:01:7E:07	HDP520	2.41.DP520	192.168.0.156
3926054176	00:03:EA:02:D5:20	HCP504	2.42.CP504	
3926120052	00:03:EA:03:D6:74	HCV73	2.55.CV73	192.168.0.32
3926181499	00:03:EA:04:C6:7B	HCV73	2.55.CV73	192.168.0.41
3927000016	00:03:EA:11:43:D0	HCV91	3.3.CV91.9722	192.168.0.31
3927000114	00:03:EA:11:44:32	HCV91	3.3.CV91.8222	192.168.0.30
3927000751	00:03:EA:11:46:AF	HCV91	3.3.CV91.9722	192.168.0.162
3927061592	00:03:EA:12:34:58	HCV91	3.4.CV96.9b20	192.168.0.181

Fig.55 Browse NetAgent

### Refresh

This will re-search all the NetAgent in the network

### 2.4.2 Serial Port Debug

This function is to know the immediate communication between NetAgent and UPS via serial port

#### Port Information

This is to configure the communication parameter between NetAgent and UPS. Parameters are Debug Mode; Port; Speed (Baud), Data Bits;Parity and Stop Bits.

Two encoding formats: ASCII or Hexadecimal.

If Debug mode is set as manually, user may enter its parameter under Send Contents column.

#### Sent Information

This column shows the real time sent command

#### Received Information

This display the response that NetAgent receives from UPS

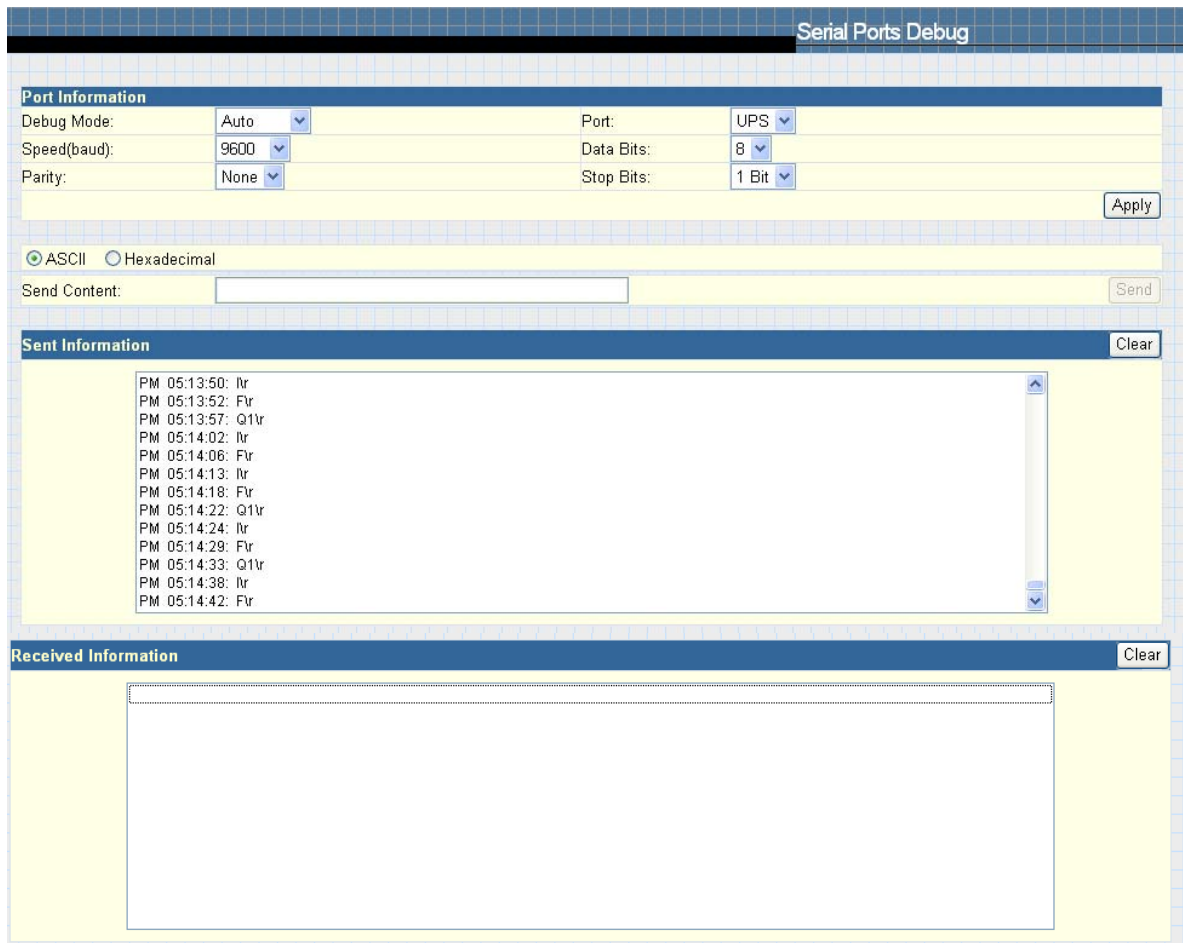

Fig.56 Serial ports debug

### 2.4.3 Help

This to help to illustrate the operation of NetAgent

### 2.4.4About

#### **About**

This to check Netagent's Firmware/Hardware version and serial number

#### **Save/Restore Settings**

Click Save to save the configuration to your PC. The text file will have a default format of YYYY\_MMDD\_####.cfg. Administrator permission required.

#### **Restore previous configuration**

Use this function to restore a \*.cfg configuration that has been saved earlier. Click Browse... to the location of the file and click **Restore**.

#### **Reset to factory default**

This function will reset all settings to its default value.

## Firmware Update Setting

Default FTP server is set as <ftp.icv99.com> with its username/password. Click on Update Now, NetAgent will connect to the FTP server and upgrade to the latest firmware version accordingly.

## Auto Update

This is to configure the period of time to check if any updated firmware in FTP and upgrade automatically.

## Firmware Update

When click , it links to <http://www.megatec.com.tw/Download.htm#NetAgent> to download the available firmware

The screenshot shows the 'About' page of the NetAgent web interface. The page has a blue header with the word 'About' on the right. Below the header, there are three main sections:

- About:** A table showing system information:

Firmware Version	2.42.BP506
Hardware Version	HBP506
Serial Number	3926048866
- Save/Restore Settings:** A form with three rows:

Save current configuration		Save
Restore previous configuration	<input type="text"/> 瀏覽...	Restore
Reset to factory default		Reset
- Firmware Update Settings:** A form with three rows:

FTP Server	<input type="text" value="ftp.icv99.com"/>
User	<input type="text" value="netagent"/>
Password	<input type="password" value="*****"/>

Below these sections, there are two rows of settings:

- Update Now >>** and **Apply** buttons.
- Auto Update:** Every  At  (Hour : Minute) **Apply**

At the bottom left, there is a **Firmware Update** button. At the bottom right, there is contact information for Mega System Technologies, Inc.:

Mega System Technologies, Inc.  
Tel: +886-2-87922060 Fax: +886-2-87922066  
E-mail: netagent@megatec.com.tw  
<http://www.megatec.com.tw>

Fig.57 About

## Chapter 6. Telnet (Remote Configuration)

### Section1. Introduction

NetAgent supports multiple Network Management systems and LAN protocols. After finishing hardware installation, you are now able to choose any utilities that provided by NetAgent to monitor and control UPS.

Here are introduction for using Telnet.

### Section2. Telnet Configuration

- 1 Select "Start" from Windows, click "Run" to key-in NetAgent IP Address

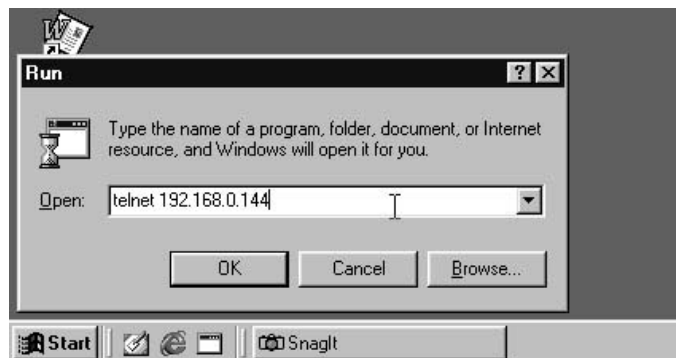

Fig.58 Telnet startup

- 2 Successful link-up display:



Fig.59 Telnet Connection

- 3 Initial to setup, please press "Enter" to enter telnet main screen. If the User Name and Password had been set before, please enter actual value to access.



Fig.60 Telnet: Input User Name / Password



④ Main screen is as follows:



Fig.61 NetAgent Telnet window

**1. Set IP Address.**

This function allows you to setup IP Address, Gateway Address, Subnet Mask parameters.

**2. Set SNMP MIB System.**

This function allows you to set the MIB system group parameters.

**3. Set SNMP Access Control.**

This function allows you to set the Manager IP, Community, Access Permission.

Note: The configuration of 'Set SNMP Access Control' is only used for SNMP Network Manager.

**4. Set SNMP Trap Notification.**

If you want to use a PC and perform the 'Trap' function of SNMP manager to manage UPS through Net Agent, the IP address of the PC must be added in this list of Net Agent.

Note: The configuration of 'Set SNMP Trap Receiver' is only used for SNMP Network Manager.

**5. Set UPS Properties.**

This allows you to setup the Communication Type of UPS, UPS Device Name and Battery Replacement Date.

**6. Set UPS Devices Connected.**

This allows you to setup the System Name, Rating which connected., Connected.

**7. Set System Time & Time Server.**

This allows you to setup the System date, time and two time servers.

**8. Set Web and Telnet User Account.**

This is allows to set users account's authority.

**9. Set E-mail.**

This is allows to set e-mail accounts to receive power event notification for emergency management.

**a. Reset Configuration to Default.**

Set all values to their default settings.

**b. Save & Reboot.**

Save the current configuration data, including any changes you have made, and reboot the Net Agent.

**0. Exit Without Saving.**

Exit, all configuration changes will be lost.

### Section3. Telnet Configuration

Use Putty software to configure SSH Telnet encryption on NetAgent 9.

This only apply to NetAgent 9 models of CX, DX and BX. (Refer to page 19 to enable SSH port of 22)

Following is the configuration of SSH Telnet

- 1 Enter the IP address of NetAgent 9 and click on Enter

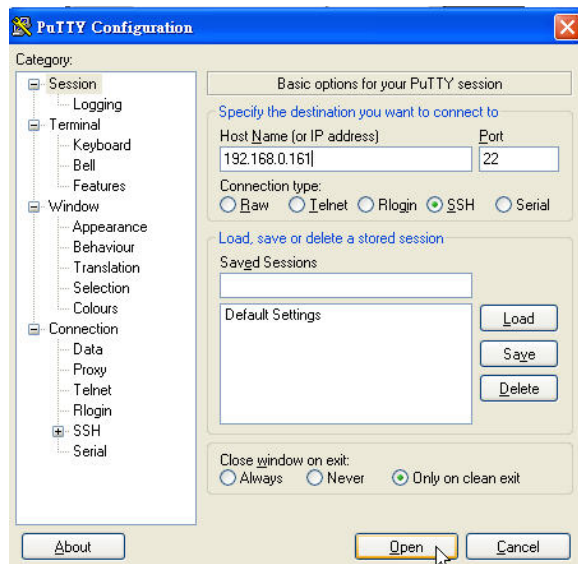

- 2 Enter the username / password



- 3 Main Menu

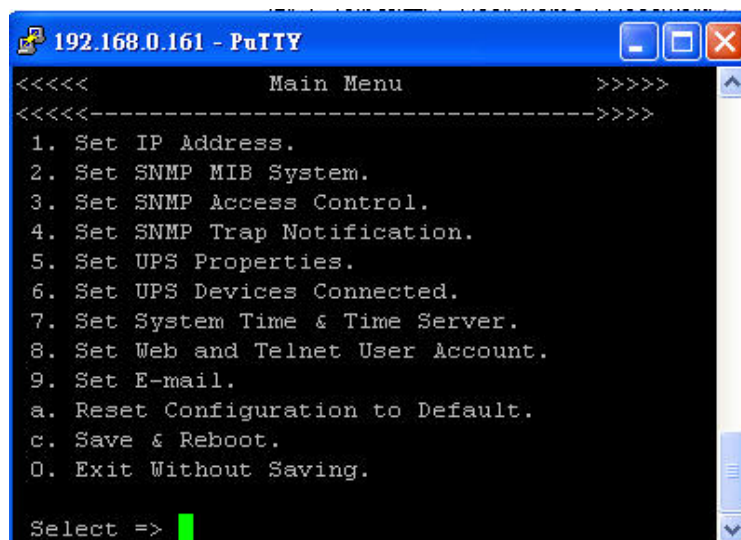

## Chapter 7. ClientMate - Windows Shutdown Utility

ClientMate is a utility for connecting to NetAgent. This utility is for the Windows platform. When the ClientMate get the power failure signal from the NetAgent. The ClientMate will save the files and shutdown the system gracefully. When the hardware installation of the NetAgent has been completed, you could install the ClientMate on any of the Windows system on the network. When the ClientMate detects the AC Fail, Battery Low, Schedule Shutdown signals from the NetAgent, it will save the file and shutdown the system. Please check the operation description here below.

### Section1. Install ClientMate

- 1 Put the NetAgent Utility CD into the CD driver. And execute the "ClientMate" program.
- 2 After complete installation, there will be a 'ClientMate' group in the Windows Start group.

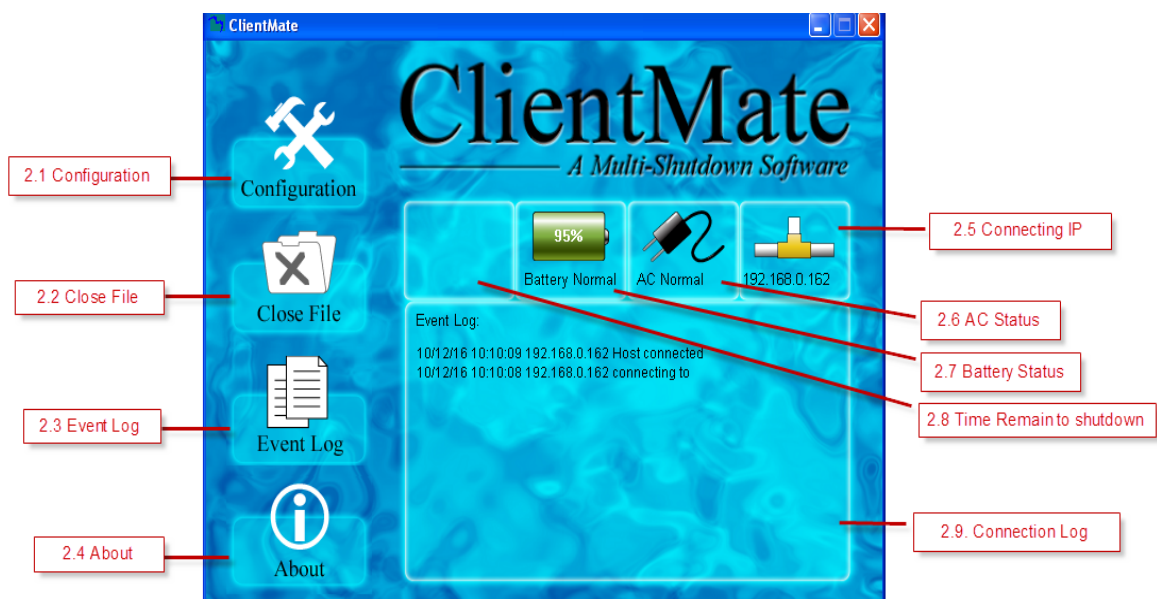

Fig.62 ClientMate Group

- 3 Click "ClientMate" to initiate the ClientMate and start using the ClientMate.

### Section2. Using ClientMate

Please find the ClientMate main window here below:press the left icon to enter the configuration dialog. On the right of the window is the current status of the UPS.



## 2.1 Config

When the ClientMate gets the signal from the NetAgent about the AC power failure or battery low signals, the ClientMate will based on the configuration below to initiate the shutdown process. The details of the configuration are here below.

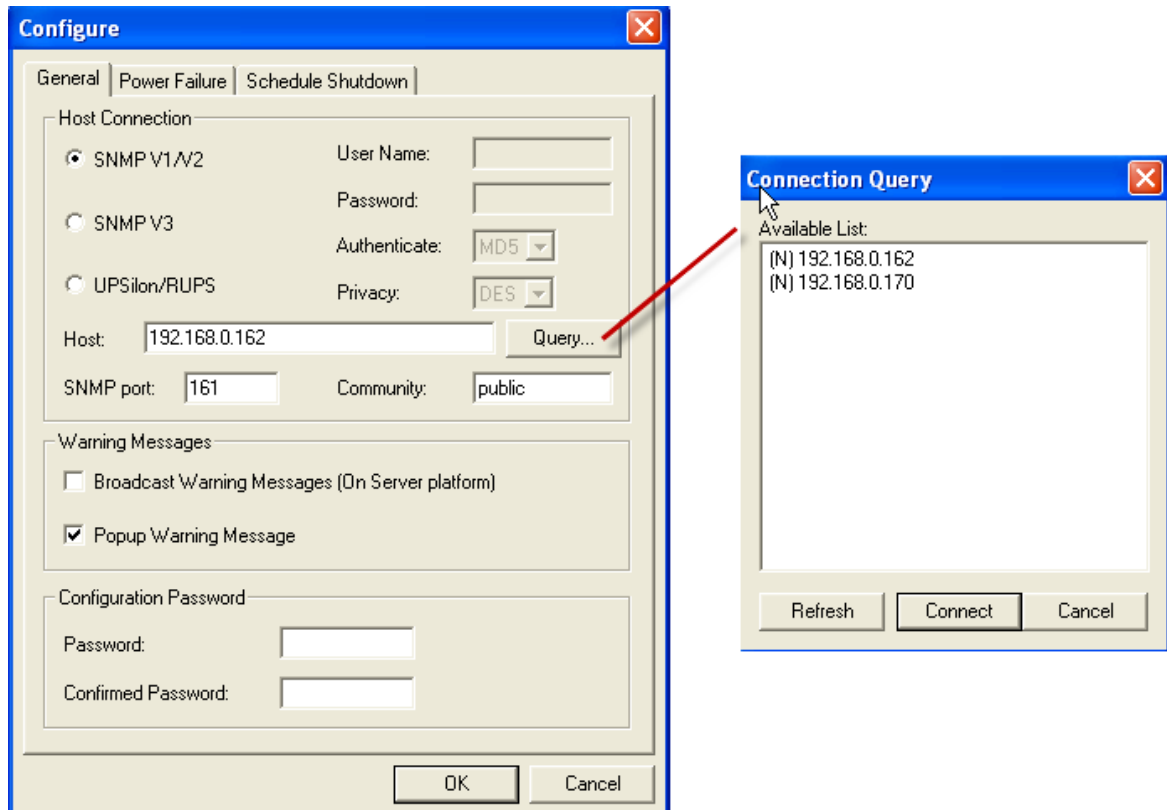

Fig.63 ClientMate: Configuration

## General

### i. Host Connection

This is to configure how ClientMate connects with NetAgent; NetAgent 9 or UPSilon / RUPS 2000.

SNMP V1 /V2 : This is default to connect with NetAgent or NetAgent 9

SNMP V3 : This only use on NetAgent 9. NetAgent 9 uses SNMP V3 protocol to connect with ClientMate. When select such communication, it requires to enter username/ password and appropriate authentication and privacy. ( SNMP V3 configuration may refer to SNMP of the NetAgent )

UPSilon / RUPS : To connect with UPSilon or RUPS server by entering the IP address of the PC

### ii. Host

Press the "Query" to search the host on the network automatically. If a host located on different network segment. Please input the IP in the HOST edit box. The IP searched on the Connect Query:

(N): The NetAgent Host

(S): The UPSilon2000 or RUPS2000 Host

**iii. SNMP Port and Community Name (For NetAgent only)**

The community name and SNMP port must be the same as configured on NetAgent. Default SNMP Port is 161

**iv. Broadcast Warning Messages (On Server platform only)**

To configure if sending the warning messages when power failed (only for WinNT, Win2000 and XP server operating system)

**v. Configuration Password**

To set if password is require to be entered when effect any new setting on ClientMate. If lost of password, just re-install the ClientMate.

## **Power Failure**

**vi. Use Windows ACPI Interface**

To shutdown the server via Windows ACPI

**vii. Shutdown Windows**

To configure if shutdown or Sleep the Windows system when power failure.

**viii. When AC failed, commence computer shutdown sequence in xx Min.**

To configure the time delay between the AC failure and the system shutdown.

**ix. When Battery Low, commence computer shutdown sequence in xx Min.**

To configure the time delay between the Battery Low and system shutdown.

**x. When Bettery capacity reaches to X %**

To configure to shutdown when battery capacity meets at \_ %

**xi. Auto save application files**

Check if to save the application files before system shutdown

**xii. Run Application before shutdown computer**

Execute the application before system shutdown.

**xiii. Turn Off UPS (For NetAgent Only)**

Setting if to turn-off UPS power after system shutdown.

## **Scheduled Shutdown**

**xiv. Shutdown Windows**

To configure if shutdown or Sleep the Windows system

**xv. Notify Scheduled shutdown before xx Min.**

Time before the 'Schedule Shutdown' to make notification

**xvi. Auto save application files**

Check if to save the application files before system shutdown

**xvii. Run Application before shutdown computer**

Execute the application before system shutdown.

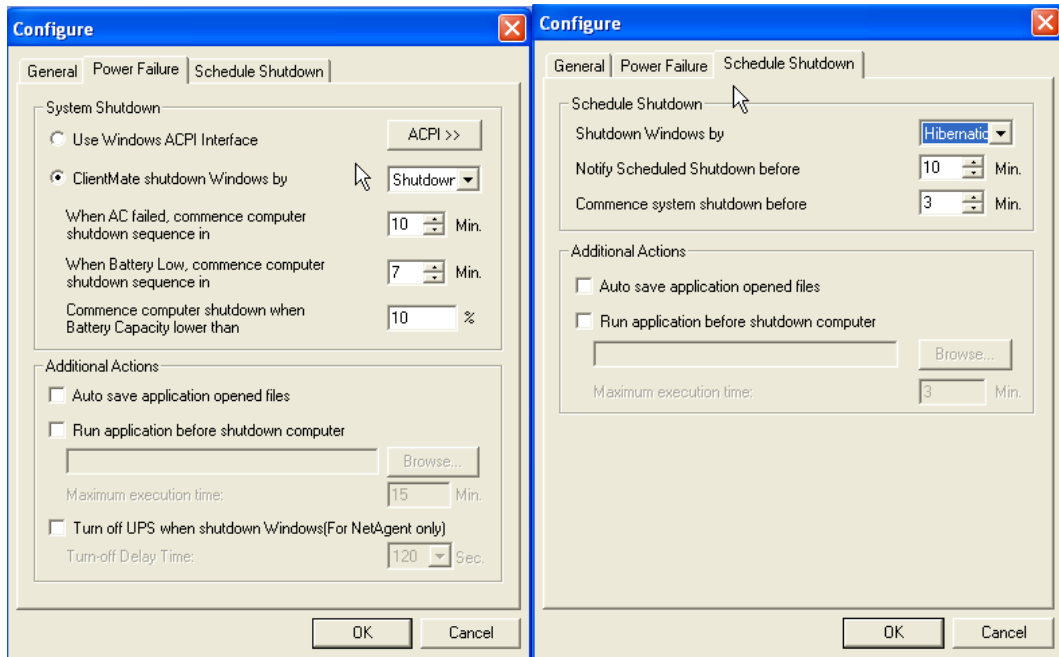

Fig.64 ClientMate Configuration

**2.2 Closed Files**

User could review all the files closed during previous shutdown process. If the “Auto save application files” function has been turn-on in the “Setting” dialog, the details of the closed application and files could be reviewed here.

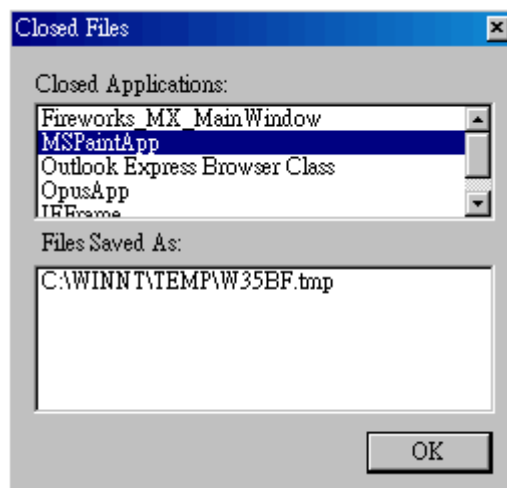

Fig.65 ClientMate: Closed Files

### 2.3 About

Press this button could review the version information of the ClientMate, as here bellowed.

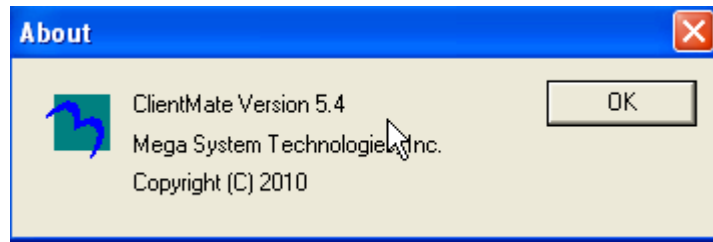

Fig.66 ClientMate:About

### 2.4 Event log

Press this button could review all the network status and UPS status happened. Shown as below.

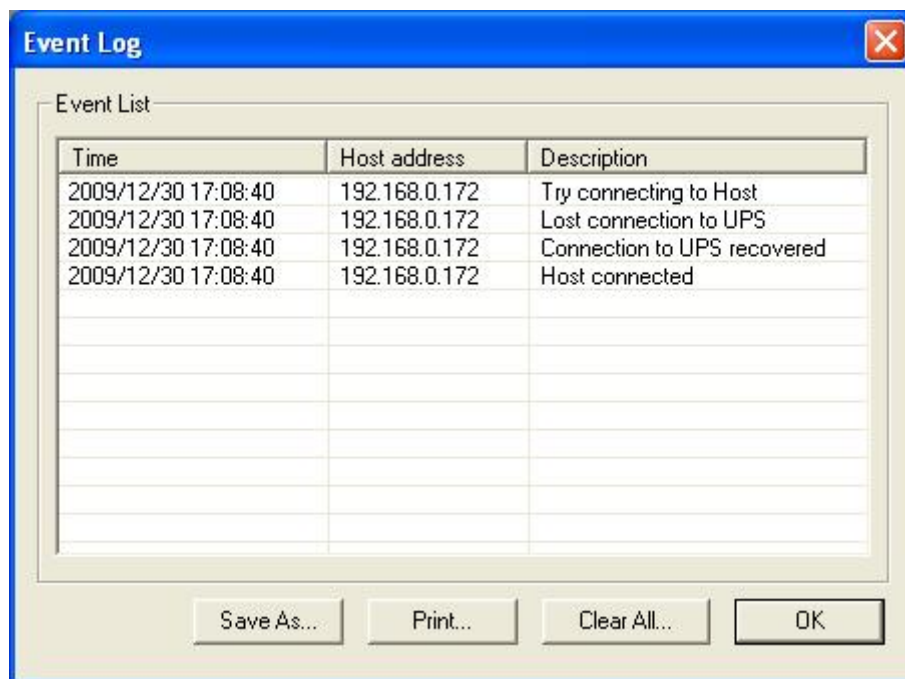

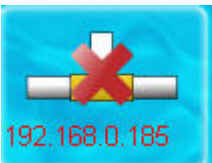



Fig.67 ClientMate:About



### 2.5 IP address of connection

Status ICON	Description
 192.168.0.162	Connecting with NetAgent UPS at IP 192.168.0.162
 192.168.0.185	Does not connect to any NetAgent.

## 2.6 AC power status

Status ICON	Description
	The connected NetAgent UPS AC power is normal.
	The connected NetAgent UPS AC power is failed.

## 2.7 Battery Status

Status ICON	Description
	The connected NetAgent UPS battery is in normal condition.
	The connected NetAgent UPS is in battery low condition.

## 2.8 Status History

On the main menu of ClientMate, the 'Status History' showing all the network status and UPS status happened.





## **Chapter 8. SNMPView – Windows Based UPS Management System**

### **Section1. Introduction**

SNMPView is a software to remotely monitor and control multiple UPS connected to a network. When an event occurs, SNMPView can be programmed to send an email or a pager to inform the designated network manager. It can also inform the user of the UPS current condition or configuration, perform self-test, send a history file, turn the UPS On/Off and more.

SNMPView features;

- ❶ A windows interface that is simple and user friendly.
- ❷ Automatic detection and identification of any UPS with NetAgent II or NetAgent Mini connected to a network.
- ❸ Capable of simultaneously monitoring up to 1,000 UPS
- ❹ Remotely control, monitor, and manage the networked UPS (Turn On/Off, Self-test, etc...)
- ❺ Able to simultaneously support both RS-232 Interface (1 or 3 phase) and Contact Closure Interface UPS.
- ❻ UPS condition displayed in either a graphic or analog bar chart.
- ❼ Supports MegaTec's SNMP Agent and SNMP Internal Card.
- ❽ Able to send email for notification
- ❾ Able to send SMS for notification

### **Section2. System Requirements**

- ❶ LAN/WAN network system with TCP/IP
- ❷ RS-232 Interface or Contact Closure Interface UPS
- ❸ External SNMP Agent or SNMP Internal Card
- ❹ Microsoft Windows 95, 98, NT, 2000, XP, Me, 2003,2008,Vista,7

### Section3. Install SNMPView

- ❶ Put the NetAgent Utility CD into the CD driver. And execute the SNMPView program.
- ❷ After installation, there will be a NetAgent group in the Windows Start group.
- ❸ Click “NetAgent” → “SNMPView” → “SNMPView for Windows” to start using SNMPView.

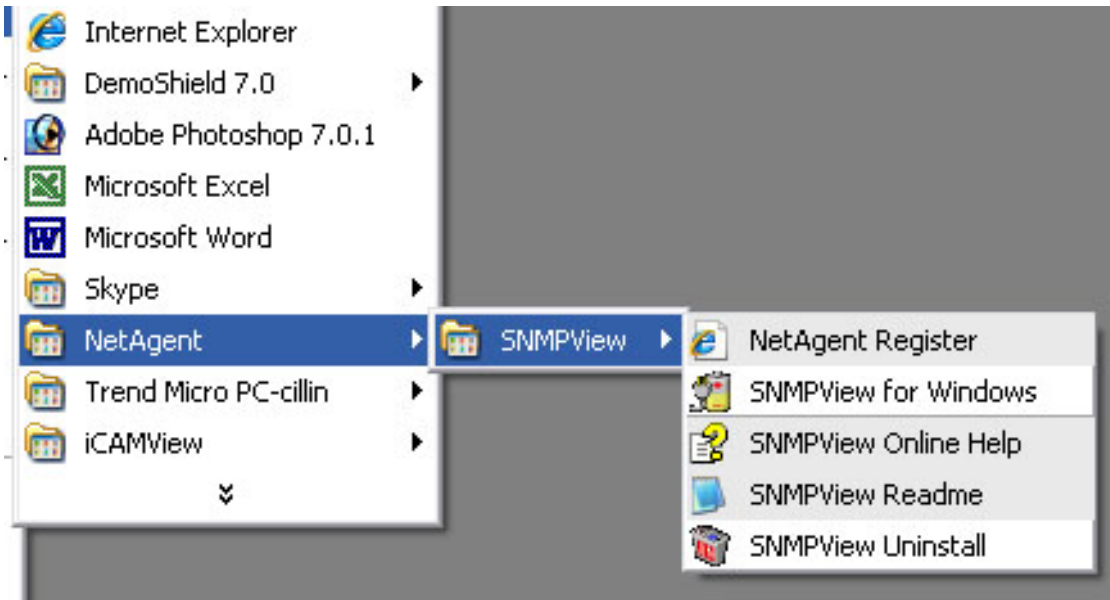

## Section4. Using SNMPView

When use SNMP view at the first time, the system will ask for input the user's name and password. Please enter the default value as follows to start the SNMPView.



**User Name: Admin**

**Password: <blank> (just press <Enter>)**

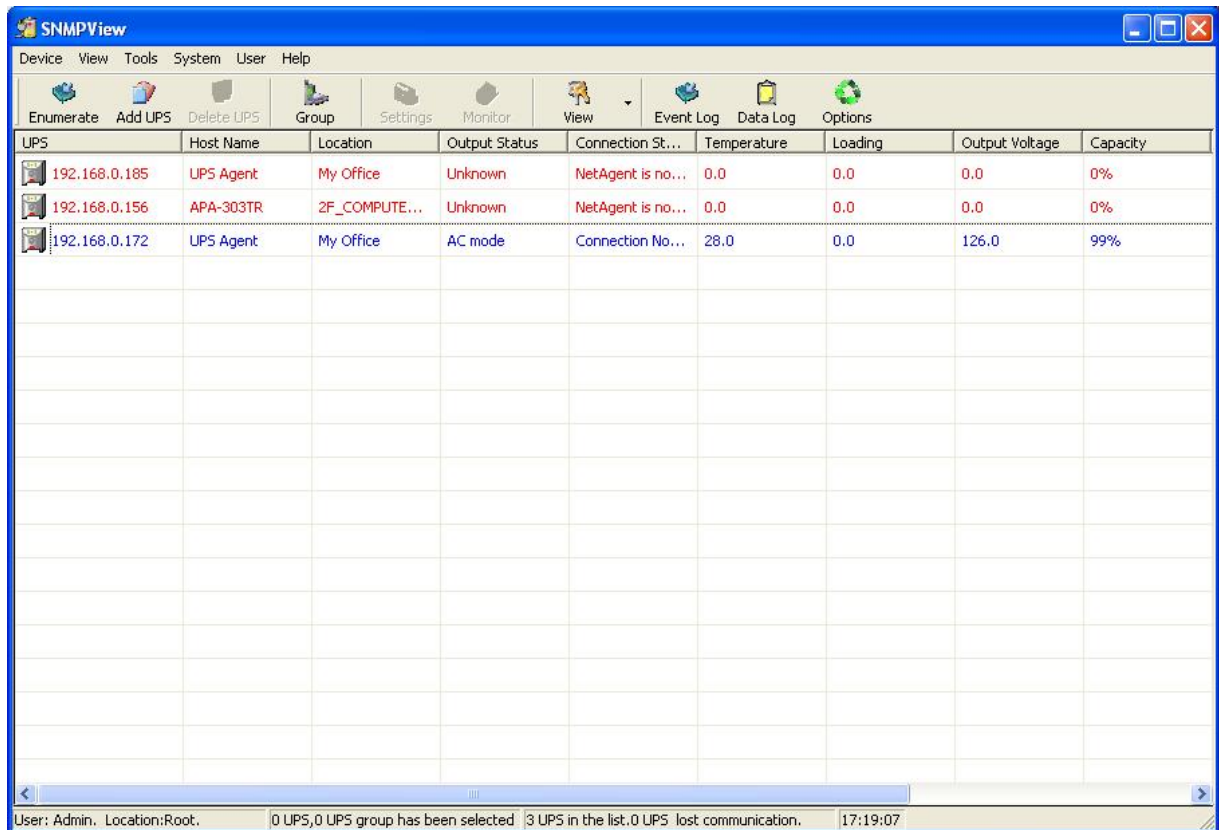
After the SNMPView program start up the main windows will be displayed. The left panel will list the available stations by area and the right panel will list the UPS, Host Name, Startup Time, Manager and Location of UPS found in each station.



The screenshot shows the SNMPView application window with a menu bar (Device, View, Tools, System, User, Help) and a toolbar with icons for Enumerate, Add UPS, Delete UPS, Group, Settings, Monitor, View, Event Log, Data Log, and Options. The main area contains a table with the following data:

UPS	Host Name	Location	Output Status	Connection St...	Temperature	Loading	Output Voltage	Capacity	
	192.168.0.185	UPS Agent	My Office	Unknown	NetAgent is no...	0.0	0.0	0.0	0%
	192.168.0.156	APA-303TR	2F_COMPUTE...	Unknown	NetAgent is no...	0.0	0.0	0.0	0%
	192.168.0.172	UPS Agent	My Office	AC mode	Connection No...	28.0	0.0	126.0	99%

The status bar at the bottom displays: User: Admin, Location:Root, 0 UPS,0 UPS group has been selected, 3 UPS in the list,0 UPS lost communication, 17:19:07



Shows that the device is a UPS



Shows that the UPS is Battery Low



Shows that the UPS is Disconnect / Off-Line

## Section5. SNMPView Buttons

When use SNMPView, configuration could be done by all function icons displayed or right click on the mouse to show functions list.

Followings are the explanation of each function icon:

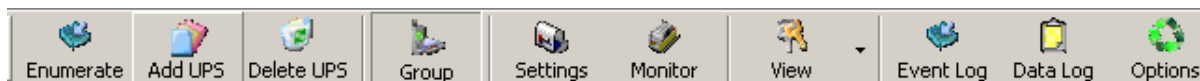

<b>Enumerate</b>	:	Search all SNMP hosts that supports Public group and display them on the screen
<b>Add UPS</b>	:	Manually add a host into the window
<b>Delete UPS</b>	:	Manually delete a host into the window
<b>Group</b>	:	Shows the Main group windows
<b>Settings</b>	:	If the host is a UPS, just click on it to view and modify the UPS's general information
<b>Monitor</b>	:	If the host is a UPS, just click on it to start monitoring UPS
<b>View</b>	:	Display in either, Large icons, small icons or details
<b>Event Log</b>	:	Records the UPS, date, time and description of an event.
<b>Data Log:</b>	:	Records data of all UPS listed.
<b>Options</b>	:	Sets the SNMP Parameter for community, Trap port and UPS SNMP port

Following is the main function icons and its reference chapter.

Main List	Sub List
<b>5.1 Device(D)</b>	<ul style="list-style-type: none"> <li>• 5.1.1 Enumerate</li> <li>• 5.1.2 Add Group</li> <li>• 5.1.3 Add UPS</li> <li>• 5.1.4 Delete</li> <li>• 5.1.5 Browse Device</li> <li>• 5.1.6 Export Configurations</li> <li>• 5.1.7 Import Configuration</li> <li>• 5.1.8 Open archive Event Log</li> <li>• 5.1.9 Open archive Data Log</li> <li>• 5.1.10 Quit</li> </ul>
<b>5.2 View(S)</b>	<ul style="list-style-type: none"> <li>• 5.2.1 Large Icons</li> <li>• 5.2.2 Small Icons</li> <li>• 5.2.3 Details</li> <li>• 5.2.4 Map Background</li> </ul>
<b>5.3 Tools(P)</b>	<ul style="list-style-type: none"> <li>• 5.3.1 UPS Settings</li> <li>• 5.3.2 UPS Monitor</li> <li>• 5.3.3 SNMP Management</li> </ul>
<b>5.4 System(S)</b>	<ul style="list-style-type: none"> <li>• 5.4.1 Event Log</li> <li>• 5.4.2 Data Log</li> <li>• 5.4.3 SNMP Option</li> </ul>
<b>5.5 User(U)</b>	<ul style="list-style-type: none"> <li>• 5.5.1 Change Password</li> <li>• 5.5.2 Account Management</li> </ul>
<b>5.6 Help(H)</b>	<ul style="list-style-type: none"> <li>• 5.6.1 Help</li> <li>• 5.6.2 About</li> </ul>

## 5.1 ENUMERATE(D)

Start SNMPView and press the “Enumerate” button, SNMPView will start a search for all the NetAgent on network and list them in the main window.

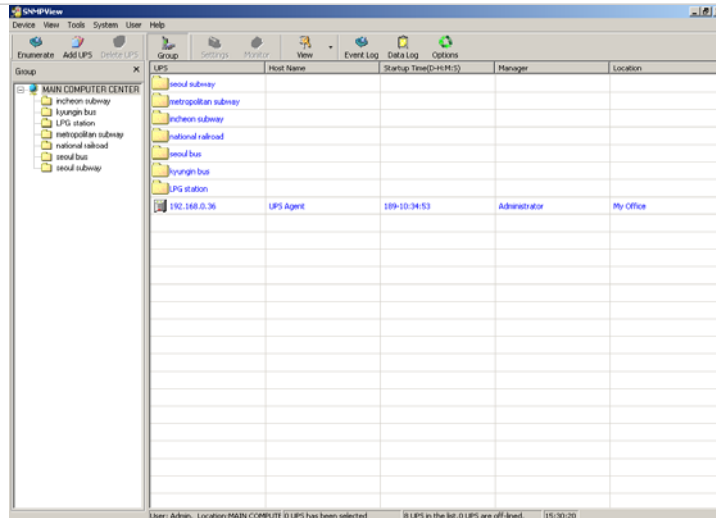

### 5.1.1 Enumerate

When press , SNMPView will start a search for all the NetAgent on network and list them in the main window.

### 5.1.2 Add Group

This is to edit or display all the group station of NetAgent under network

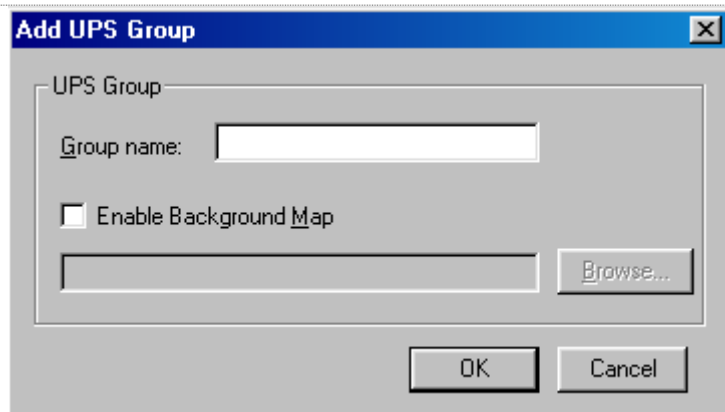

### 5.1.3 ADD UPS

Click “Add UPS” to enter the IP address of the UPS manually. Once entered, the UPS will be shown on the main list.

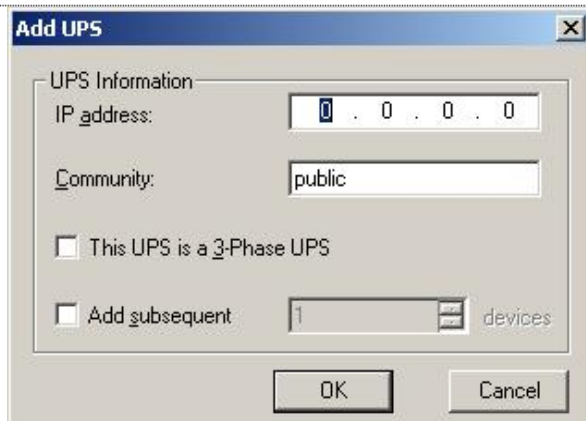

## 5.1.4 DELETE UPS

Highlight the unit to be deleted from main list and right click on it to choose Delete or use click on the Delete icon from main function list.

Hold On “Shift” to select multi NetAgent UPS

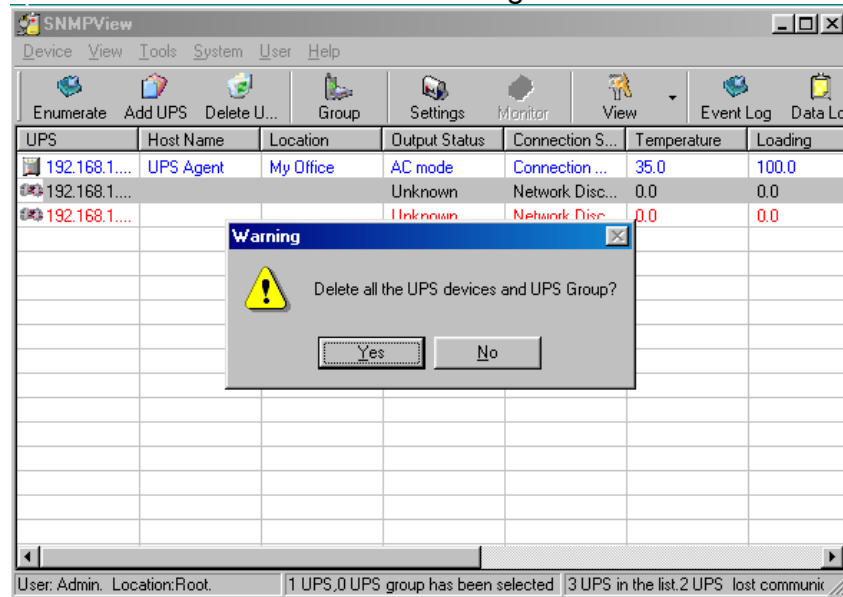

## 5.1.5 Browse Device

Highlight the unit to be browsed and click it to enter NetAgent’s webpage.

## 5.1.6 Export Configuration

This is to save the NetAgent UPS’s configuration

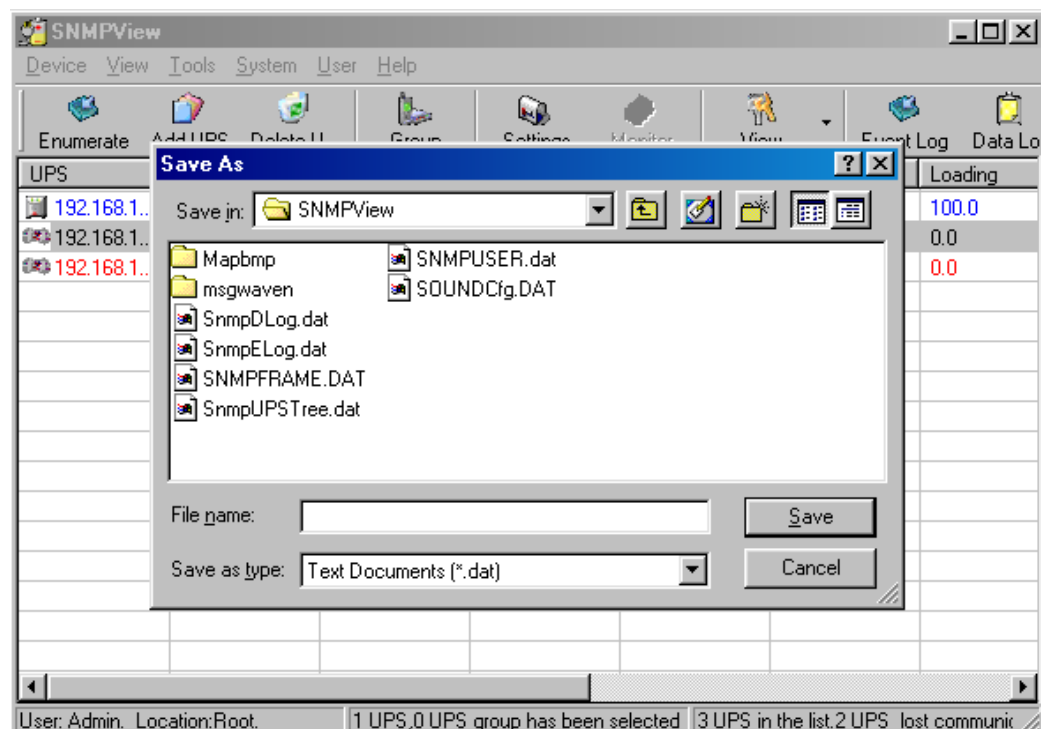

## 5.1.7 Import Configuration

This is to import the configuration of NetAgent UPS that saved

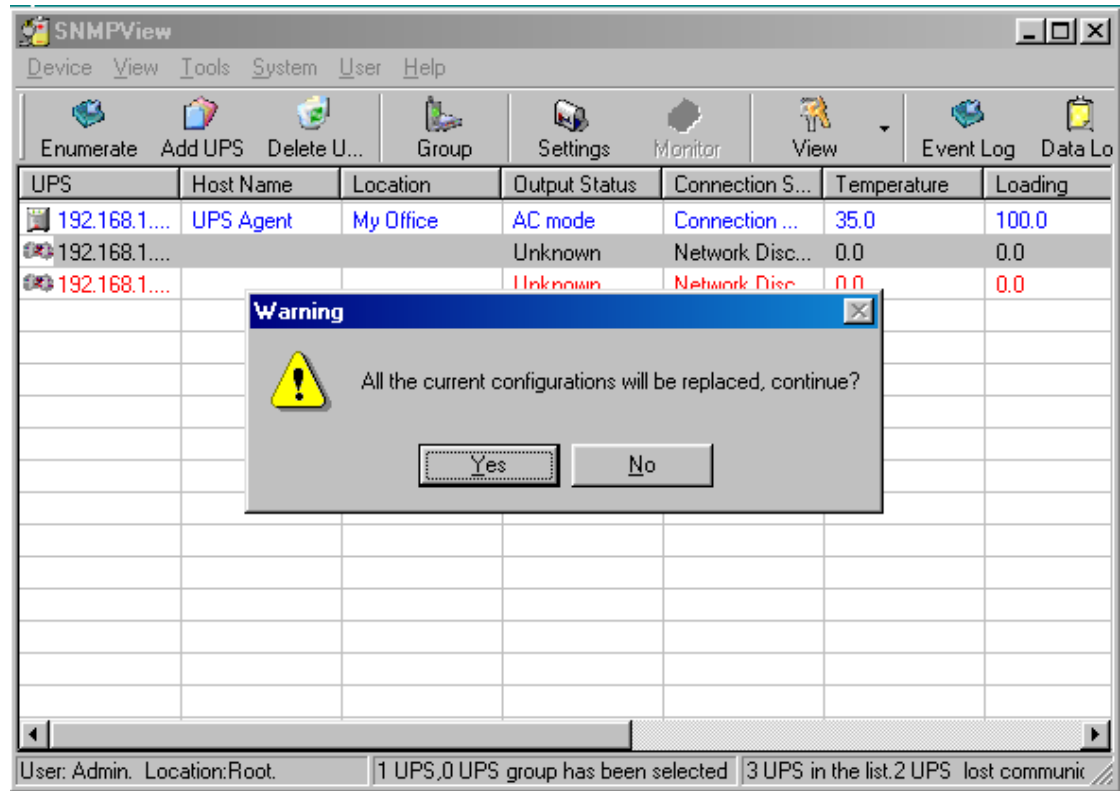

The screenshot shows the SNMPView application interface. A warning dialog box is displayed in the foreground, asking for confirmation to replace current configurations. The background shows a table of UPS configurations.

UPS	Host Name	Location	Output Status	Connection S...	Temperature	Loading
192.168.1...	UPS Agent	My Office	AC mode	Connection ...	35.0	100.0
192.168.1...			Unknown	Network Disc...	0.0	0.0
192.168.1...			Unknown	Network Disc	0.0	0.0

Warning dialog box text: All the current configurations will be replaced, continue?

Buttons: Yes, No

Status bar: User: Admin. Location:Root. 1 UPS,0 UPS group has been selected 3 UPS in the list.2 UPS lost communic



### 5.1.8 Open archive Event Log

Open up "SnmpElog.dat", SNMPView would show the event log of all NetAgent UPS:

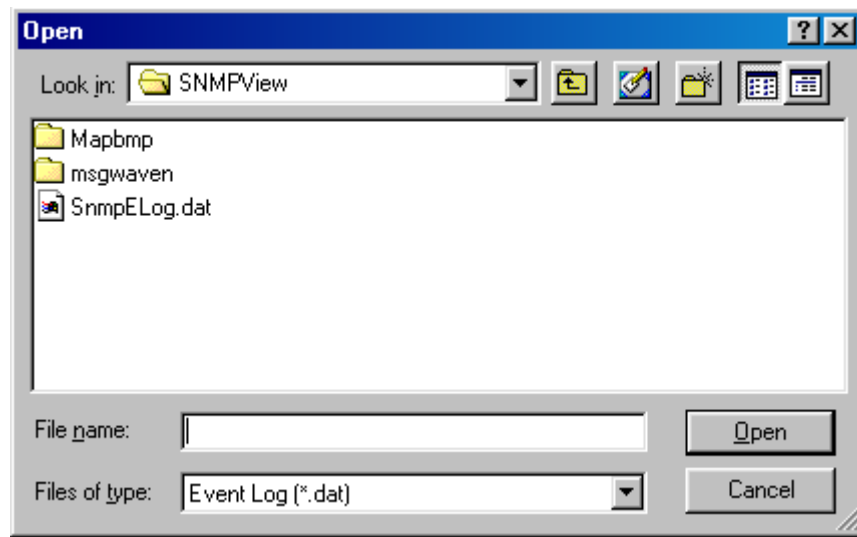

Open up "SnmpElog.dat", event log would show as below:

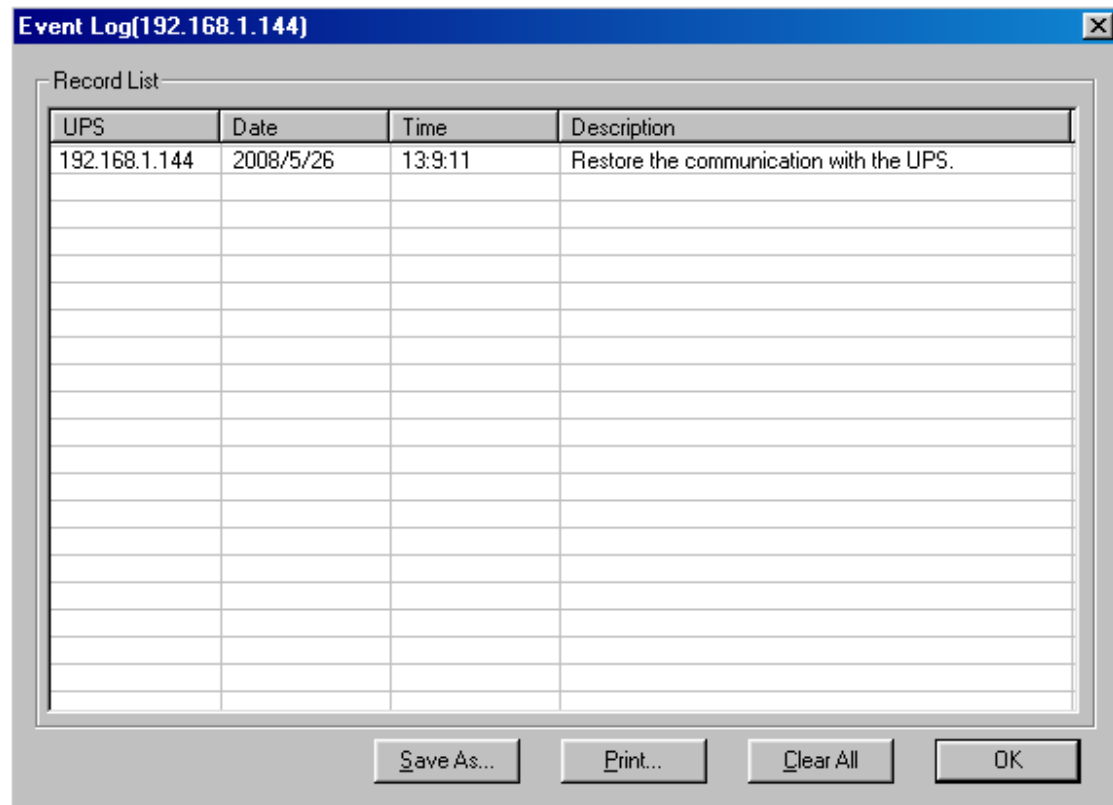

### 5.1.9 Open archive Data Log

Open up "SnmpDlog.dat", SNMPView would show the event log of all NetAgent UPS:

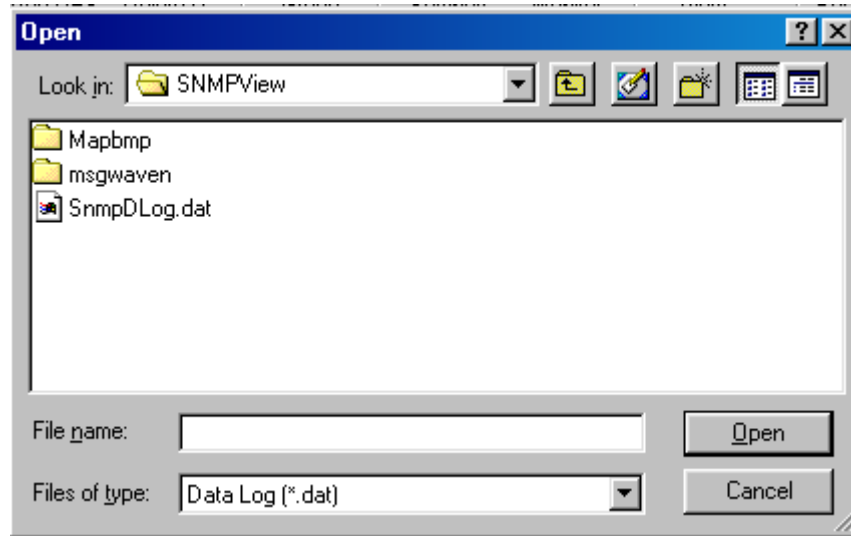

Open up "SnmpDlog.dat", data log would show as below:

The screenshot shows the 'Data Log(192.168.1.144)' window. It contains a 'Record List' table with the following data:

UPS	Host Na...	Startup ...	Input V...	Output ...	Battery ...	Capacity	Loading	Temper...	Frequen...	A
192.168...	UPS Ag...	2008/5...	208.4	208.4	21.5	100.0	100.0	35.0	59.9	A
192.168...	UPS Ag...	2008/5...	208.4	208.4	21.5	100.0	100.0	35.0	59.9	A

Below the table, there are buttons for 'Save As...', 'Print...', 'Clear All', and 'OK'.

### 5.1.10 Quit

Exit SNMPView

## 5.2 View(S)

This is to choose the presentation format of NetAgent UPS.

### 5.2.1 Large Icons

Large icon view to display IP address and its location.

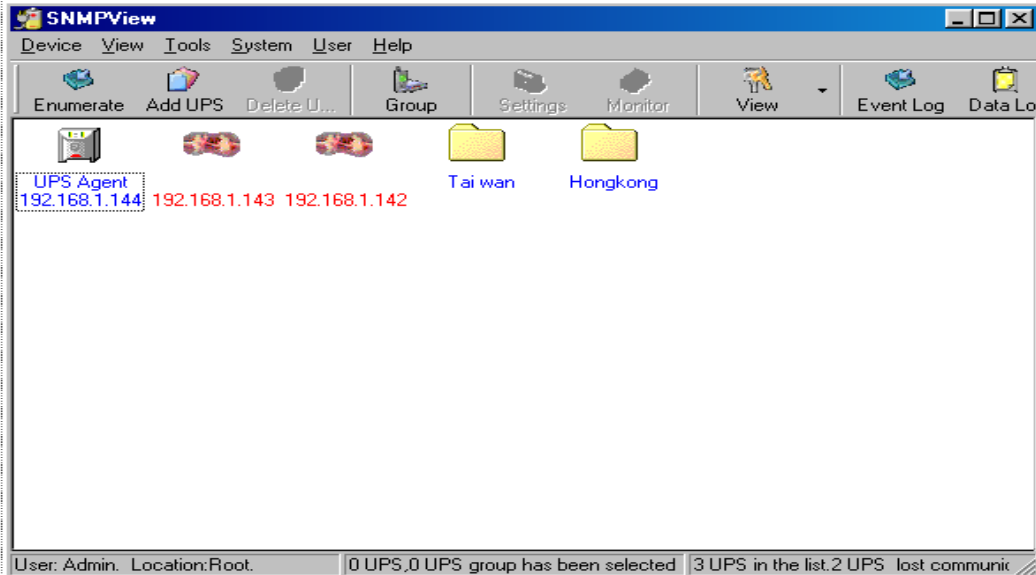

### 5.2.2 Small Icons

Small icon view to display NetAgent UPS's IP address, Name, location...etc

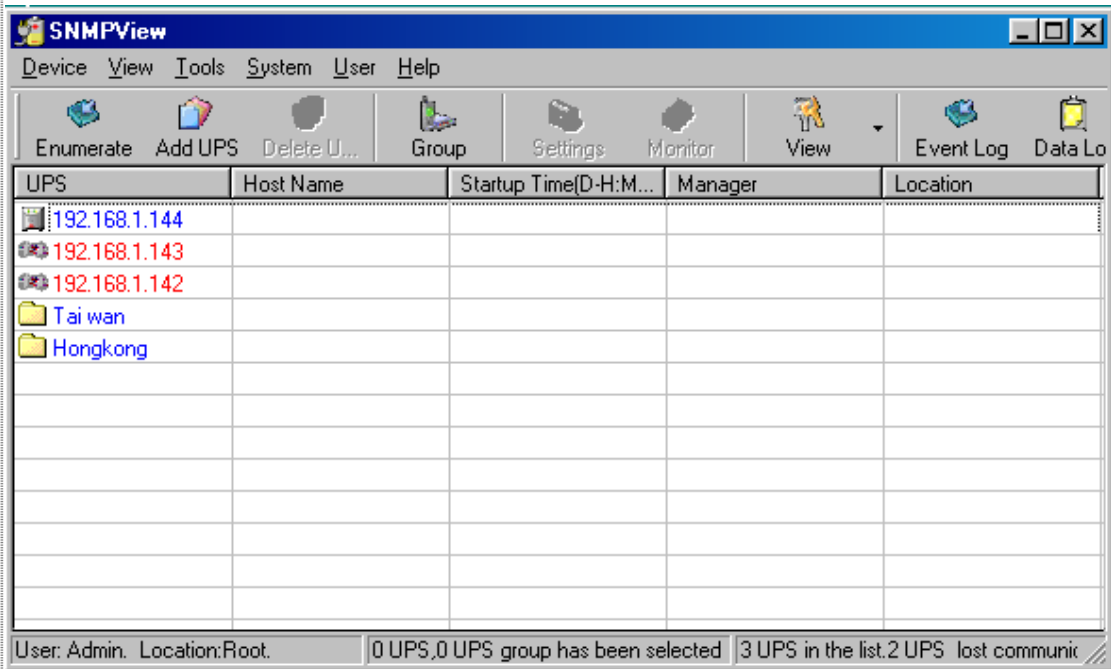

### 5.2.3 Details

Detailed Information displays NetAgent UPS's IP address, name, input voltage, output voltage, battery capacity, load, frequency..etc.

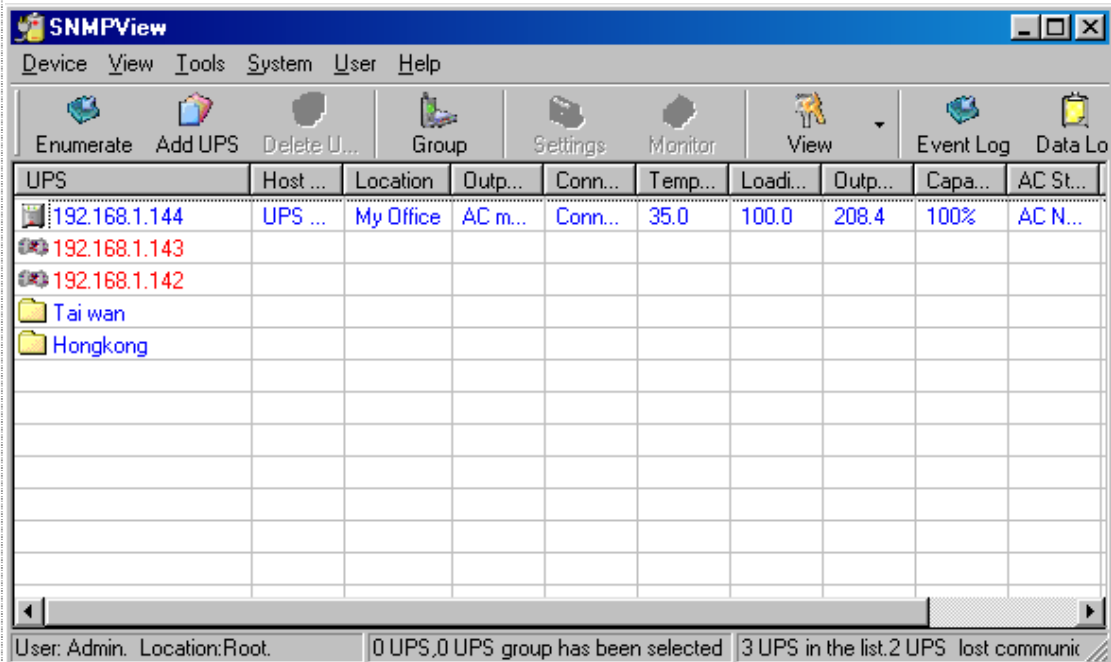

### 5.2.4 Map Background

Import a map image (JPG) by right click on the main screen and move NetAgent UPS icon to its suitable location.

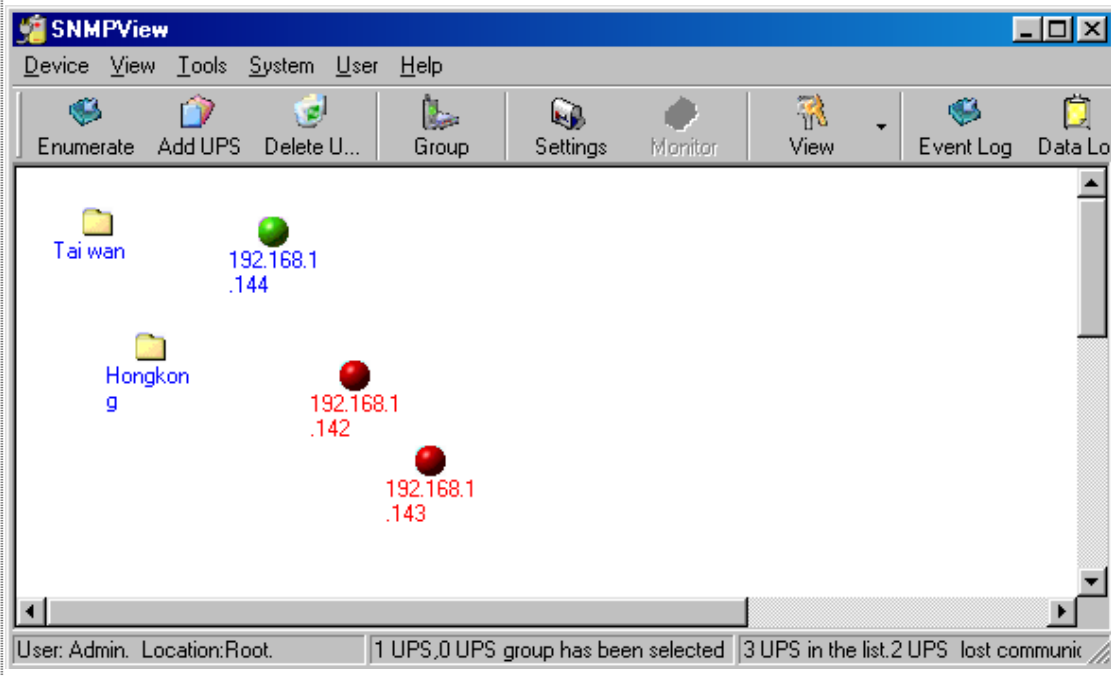

## 5.3 Tools(P)

Highlight NetAgent UPS device and configure.

### 5.3.1 Settings

#### General

This to configure UPS information, record UPS event, enable trap alarm..etc

#### Email

Send email notification when event occurs

- ◆ Sender Display name: Please enter sender display name
- ◆ Sender email address: Please enter sender email address
- ◆ SMTP server address: Enter SMTP address, IP address or domain name.
- ◆ Server requires authentication: Click Setting, then enter your Account Name and Account Password.
- ◆ Notified Email Address: Click add and enter new email address.

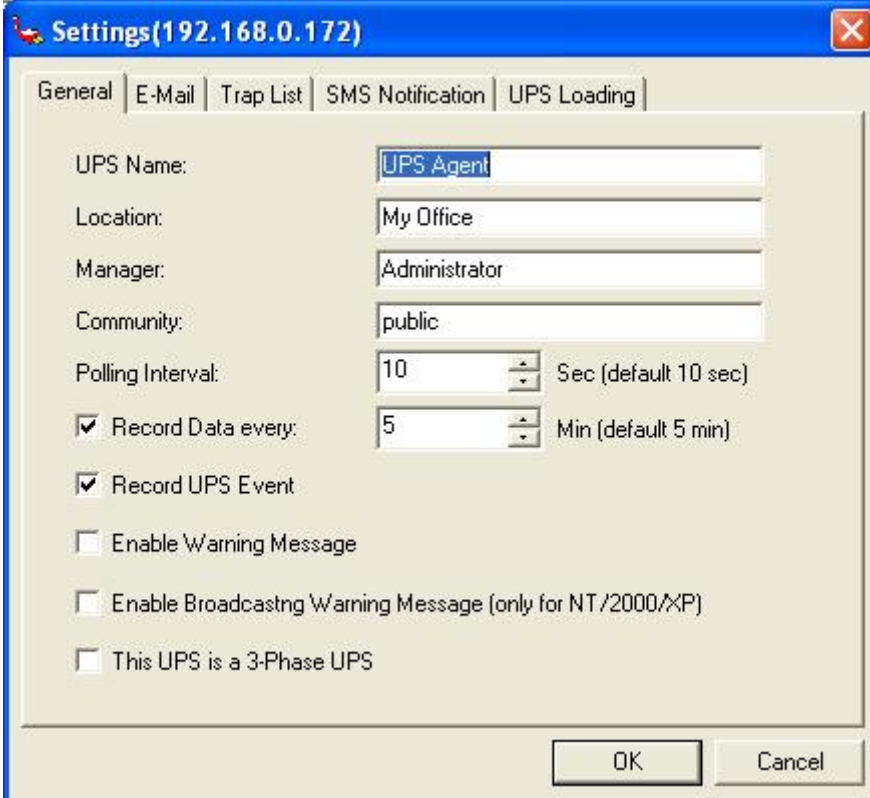

The screenshot shows a Windows-style dialog box titled "Settings(192.168.0.172)". It has a blue title bar with a close button. The dialog contains several tabs: "General", "E-Mail", "Trap List", "SMS Notification", and "UPS Loading". The "General" tab is selected. The fields are as follows:

UPS Name:	<input type="text" value="UPS Agent"/>
Location:	<input type="text" value="My Office"/>
Manager:	<input type="text" value="Administrator"/>
Community:	<input type="text" value="public"/>
Polling Interval:	<input type="text" value="10"/> Sec (default 10 sec)
<input checked="" type="checkbox"/> Record Data every:	<input type="text" value="5"/> Min (default 5 min)
<input checked="" type="checkbox"/> Record UPS Event	
<input type="checkbox"/> Enable Warning Message	
<input type="checkbox"/> Enable Broadcasting Warning Message (only for NT/2000/XP)	
<input type="checkbox"/> This UPS is a 3-Phase UPS	

At the bottom right, there are "OK" and "Cancel" buttons.

#### SMS Notification

Send SMS when event occurs

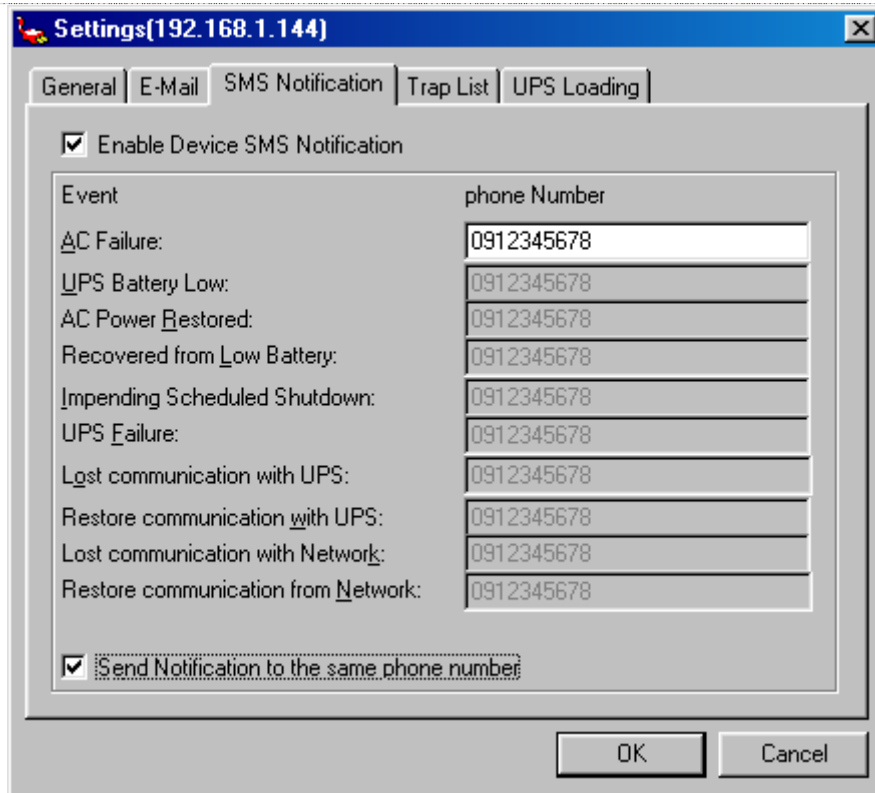

## Trap List

Double click on the trap that listed and configure

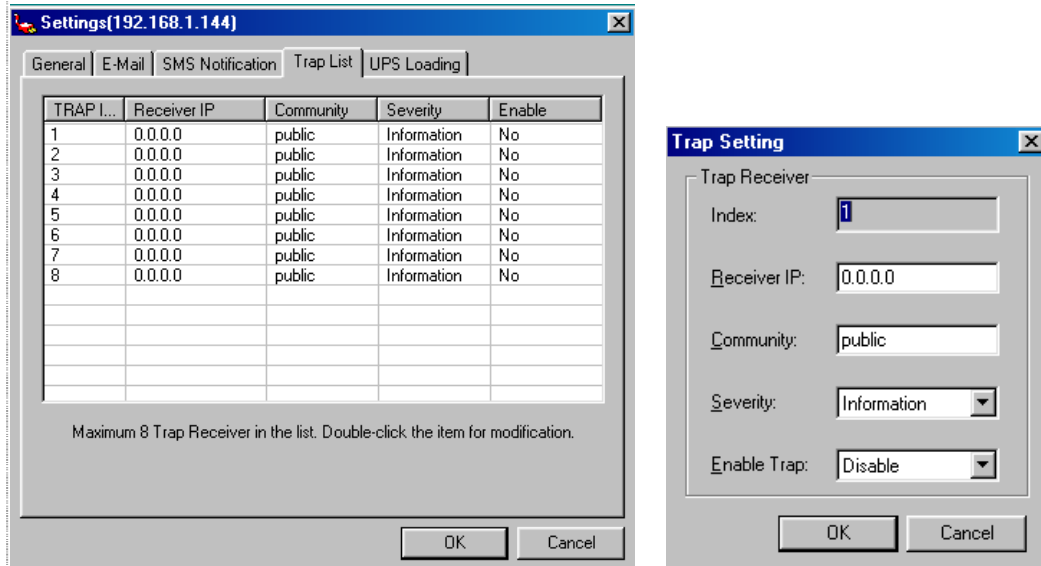

## UPS Loading

To configure all the other devices and its load that connects with NetAgent UPS. Double click on the device listed and configure

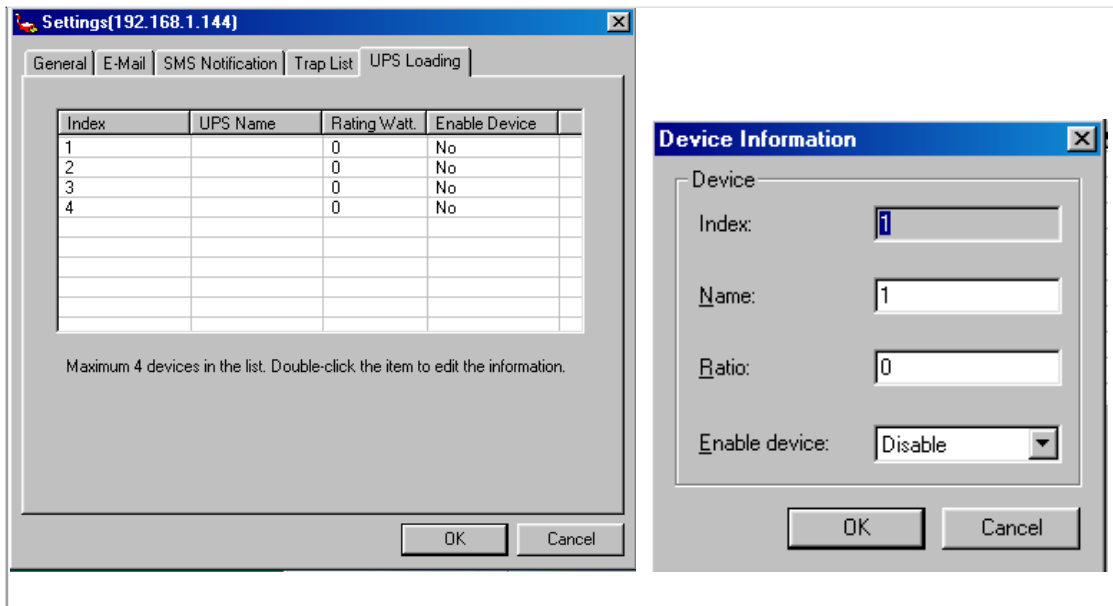

### 5.3.2 UPS Monitor

Highlight NetAgent UPS device and configure. Or right click on the highlighted device and click on monitor device

#### Meter

Display NetAgent UPS information such as input voltage, output voltage, temperature, capacity..etc in diagram.

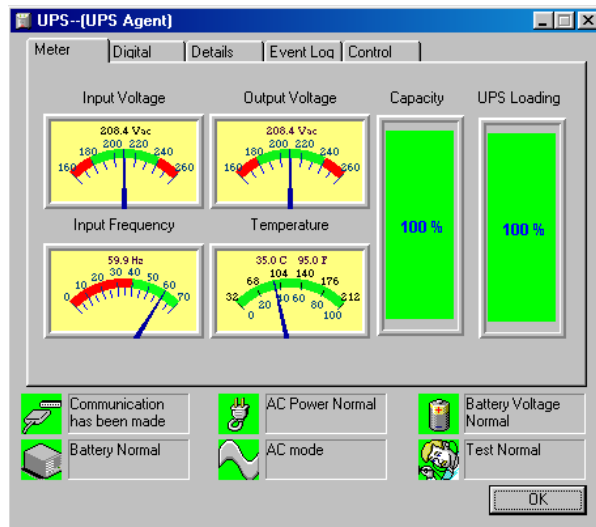

#### Digital

Display NetAgent UPS information such as input voltage, output voltage, temperature, capacity..etc in digital.

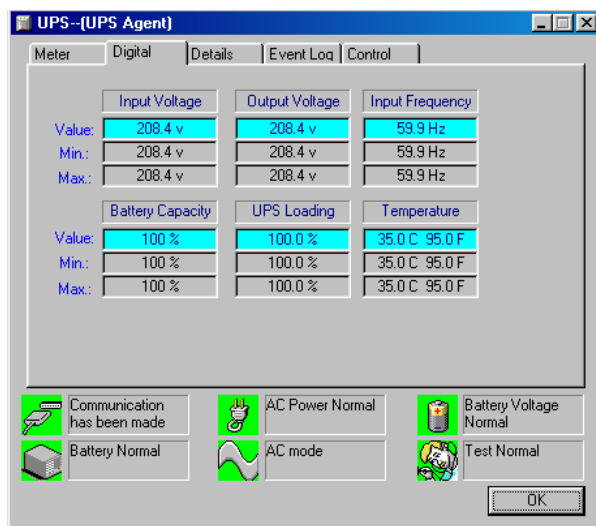

#### Details

Display NetAgent UPS's IP address, location, user, manufacturer and all other detailed information

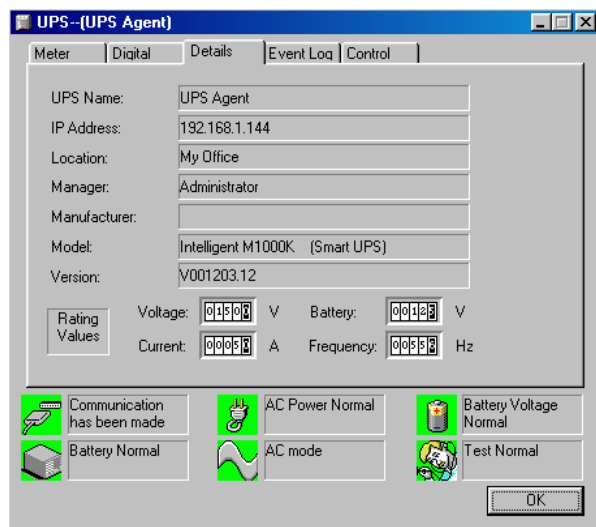



## Event Log

This display event happened with date/time and its description

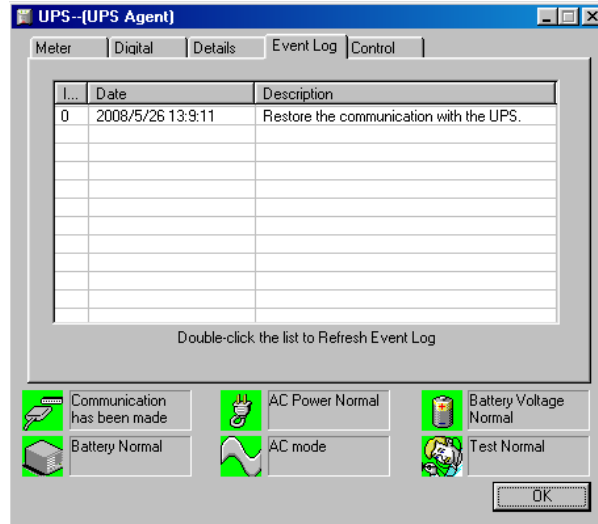

## Control

- Turn Off UPS: To shutdown UPS
- Reboot UPS: UPS shuts down in 12 seconds, and reboot in 1 minute.
- LED: Enable LED flashes. (UPS must supports it)
- Cancel Shutdown: To cancel UPS shutdown. (UPS must supports it)
- Simulate AC Fail: Simulate AC failed to UPS
- UPS Sleep: UPS enter sleep mode
- Economize UPS Battery: Turn off UPS load to save UPS battery capacity

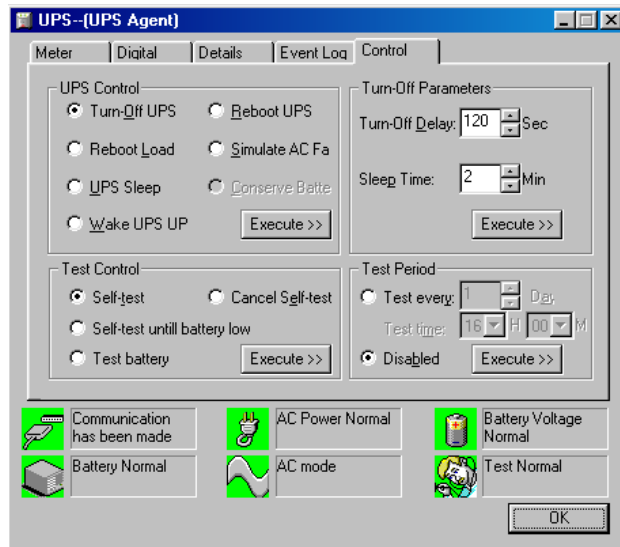

Once choose the function that to perform and click on “Execute”

Note: UPS must supports those function to perform it

#### **Test Control**

- UPS Self Test: Execute UPS Self Test
- UPS Calibration Test: Execute UPS Calibration Test

#### **Turn-Off Parameters**

- Turn-Off Delay: To set the buffering time for UPS before shutdown
- Sleep Time: To set UPS sleep time.

#### **Test Period**

- Unknown: This defined by UPS configuration.
- Two weeks: Perform UPS test every two weeks
- Weekly: Perform UPS test every week
- Disable: Do not perform UPS test

### 5.3.3 UPS Management

To configure SNMP of its NetAgent UPS

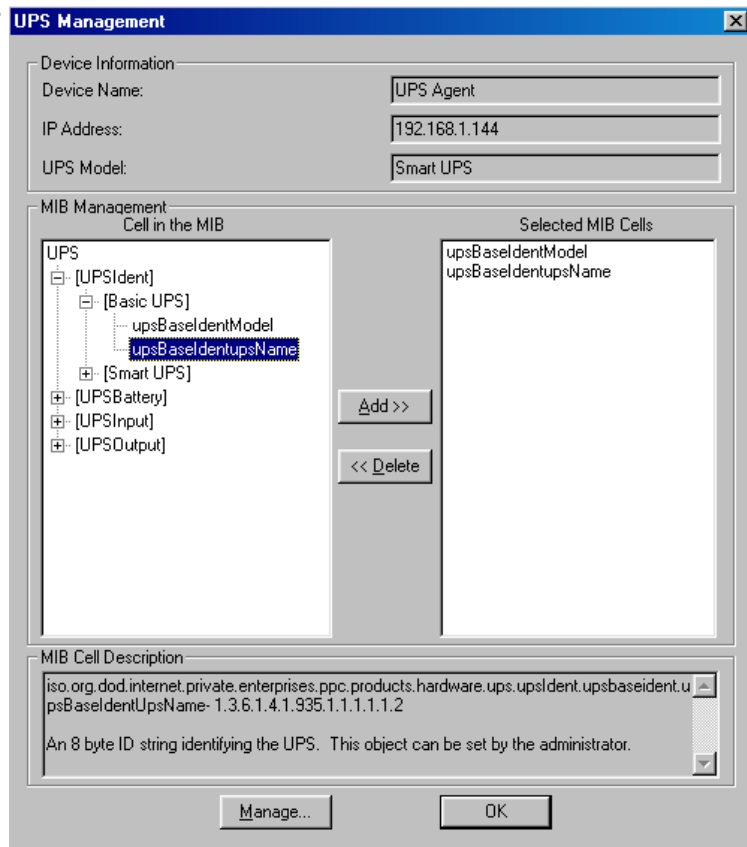

## 5.4 System(S)

To view event log, data log and configuration

### 5.4.1 Event Log

Display event log ,  
date/time and  
description of all  
NetAgent UPS

UPS	Date	Time	Description
192.168.1.144	2008/5/26	13:9:11	Restore the communication with the UPS.

### 5.4.2 Data Log

Display input voltage,  
output voltage ,  
frequency ,load..etc  
of all NetAgent UPS

UPS	Host Na...	Startup ...	Input V...	Output ...	Battery ...	Capacity	Loading	Temper...	Frequen...
192.168...	UPS Ag...	2008/5...	208.4	208.4	21.5	100.0	100.0	35.0	59.9
192.168...		2008/5...	0.0	0.0	0.0	0.0	0.0	0.0	0.0
192.168...		2008/5...	0.0	0.0	0.0	0.0	0.0	0.0	0.0
192.168...	UPS Ag...	2008/5...	208.4	208.4	21.5	100.0	100.0	35.0	59.9
192.168...		2008/5...	0.0	0.0	0.0	0.0	0.0	0.0	0.0
192.168...		2008/5...	0.0	0.0	0.0	0.0	0.0	0.0	0.0
192.168...	UPS Ag...	2008/5...	208.4	208.4	21.5	100.0	100.0	35.0	59.9
192.168...		2008/5...	0.0	0.0	0.0	0.0	0.0	0.0	0.0
192.168...		2008/5...	0.0	0.0	0.0	0.0	0.0	0.0	0.0
192.168...	UPS Ag...	2008/5...	208.4	208.4	21.5	100.0	100.0	35.0	59.9
192.168...		2008/5...	0.0	0.0	0.0	0.0	0.0	0.0	0.0
192.168...		2008/5...	0.0	0.0	0.0	0.0	0.0	0.0	0.0
192.168...	UPS Ag...	2008/5...	208.4	208.4	21.5	100.0	100.0	35.0	59.9
192.168...		2008/5...	0.0	0.0	0.0	0.0	0.0	0.0	0.0
192.168...		2008/5...	0.0	0.0	0.0	0.0	0.0	0.0	0.0
192.168...	UPS Ag...	2008/5...	208.4	208.4	21.5	100.0	100.0	35.0	59.9

### 5.4.3 SNMP Option

To set NetAgent UPS's parameter

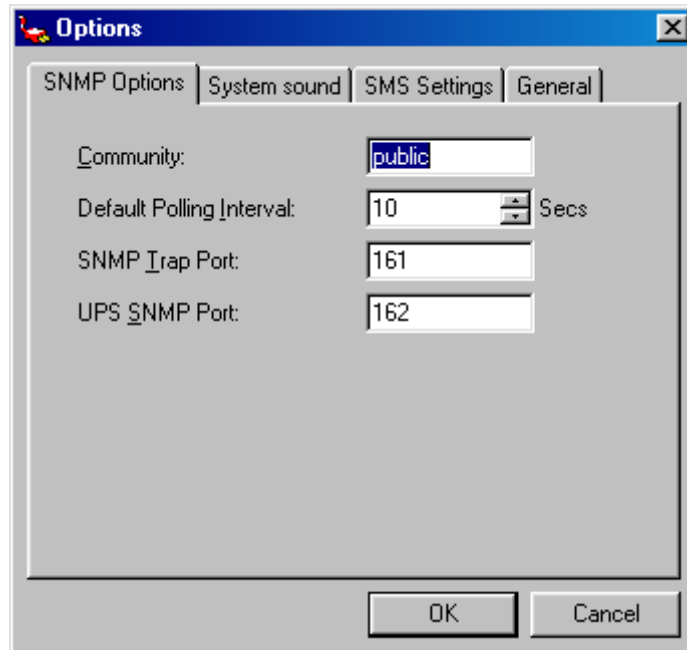

## 5.5 User(U)

Total of 8 users account can be created to manage and control its NetAgent UPS

### 5.5.1 Change Password

To change existing user's password to login



The 'Change Password' dialog box contains the following fields and buttons:

- Account Information
- Old password:
- New password:
- Confirm new password:
- OK button
- Cancel button

### 5.5.2 User Management

This only for Admin user to add, edit or remote other user's info

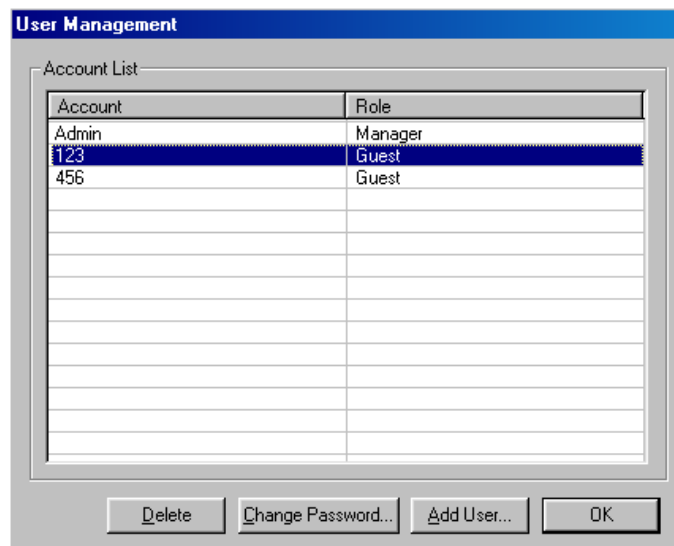

The 'User Management' dialog box displays a table of user accounts and includes the following buttons:

Account	Role
Admin	Manager
123	Guest
456	Guest

- Delete button
- Change Password... button
- Add User... button
- OK button

## 5.6 Help(H)

Display the current SNMPView version, and operation information

### 5.6.1 HTML Help

This to check the operation of SNMPView

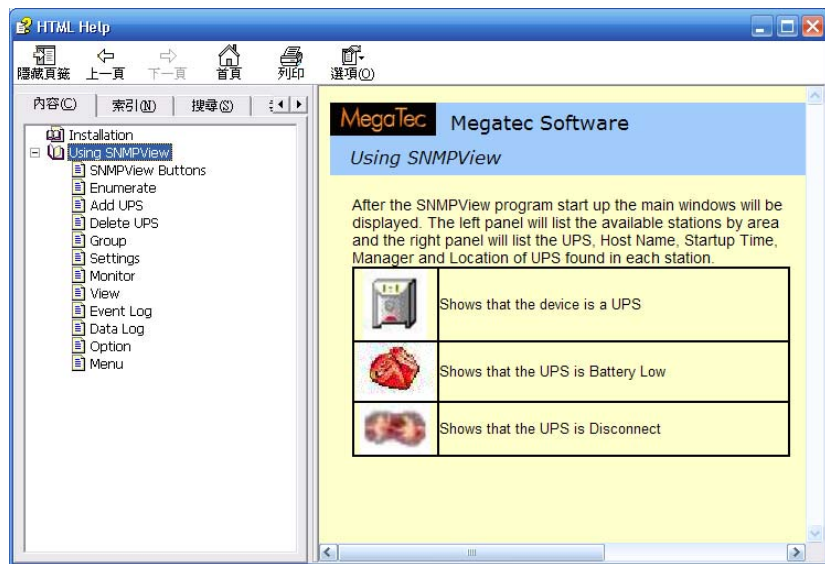

### 5.6.2 About

Display the current SNMPView version, Copyright information and product service contact.

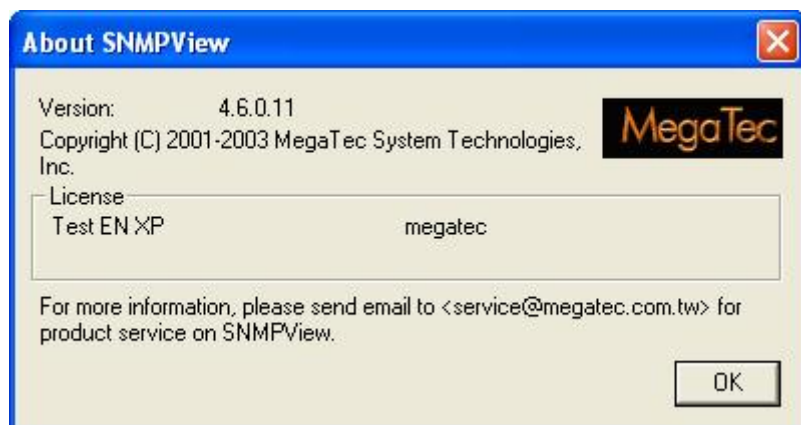

## Appendix A - Update the firmware of NetAgent UPS

NetAgent provides the following convenient methods for user to update the latest firmware of the NetAgent

1. Click firmware upgrade under About of NetAgent webpage and it would link to Megatec's server to download the latest firmware. Then use Download Firmware from Netility to upgrade it.

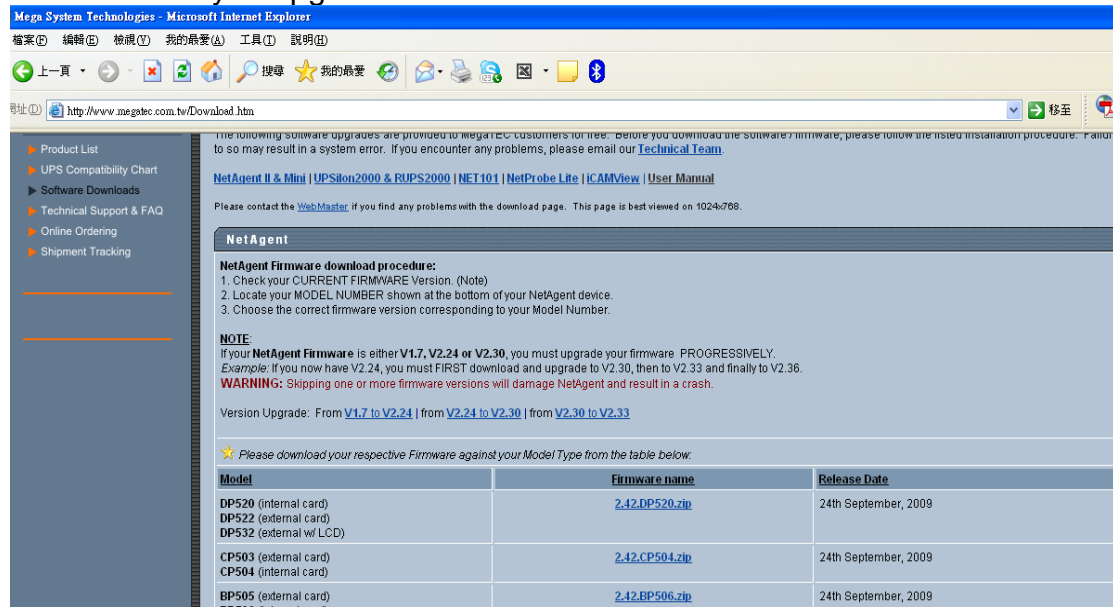

The screenshot shows a web browser window displaying the Megatec website. The page title is "Mega System Technologies - Microsoft Internet Explorer". The address bar shows "http://www.megatec.com.tw/Download.htm". The page content includes a navigation menu on the left, a main content area with a "NetAgent" section, and a table of firmware files.

The "NetAgent" section contains the following information:

**NetAgent Firmware download procedure:**

1. Check your CURRENT FIRMWARE Version. (Note)
2. Locate your MODEL NUMBER shown at the bottom of your NetAgent device.
3. Choose the correct firmware version corresponding to your Model Number.

**NOTE:**  
If your **NetAgent Firmware** is either **V1.7, V2.24 or V2.30**, you must upgrade your firmware **PROGRESSIVELY**.  
*Example:* If you now have V2.24, you must **FIRST** download and upgrade to V2.30, then to V2.33 and finally to V2.36.  
**WARNING:** Skipping one or more firmware versions will damage NetAgent and result in a crash.

Version Upgrade: From [V1.7 to V2.24](#) | from [V2.24 to V2.30](#) | from [V2.30 to V2.33](#)

★ Please download your respective Firmware against your Model Type from the table below.

Model	Firmware name	Release Date
DP520 (internal card) DP522 (external card) DP532 (external w/ LCD)	<a href="#">2.42.DP520.zip</a>	24th September, 2009
CP503 (external card) CP504 (internal card)	<a href="#">2.42.CP504.zip</a>	24th September, 2009
BP505 (external card) BP506 (internal card)	<a href="#">2.42.BP506.zip</a>	24th September, 2009



## 2. Use FTP to update (suitable for BK,CK,DK,BP,CP,DP using firmware version 2.35 and later)

The FTP is a easy and common way to upload the latest firmware into the NetAgent. Please follow the instruction below to update the firmware. If there is other FTP client application on your computer, that will also be fine to use it for updating the firmware.

For example: if wish to update the latest firmware of the NetAgent UPS which IP address is 192.168.50.179, then please operate with the steps below:

- (1) Enter Windows, then type ftp 192.168.50.179 under "Run" of the "Start Menu"

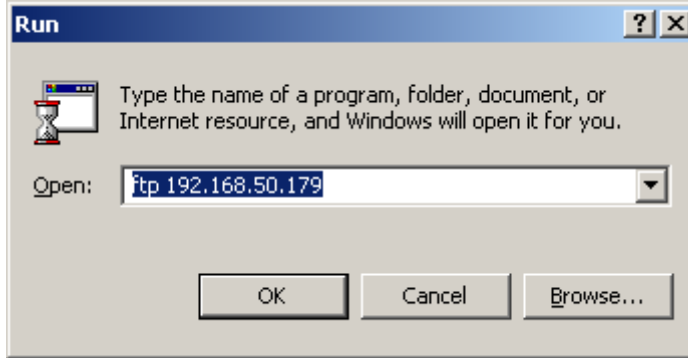

- (2) After executed, the systems will requests for the user name and password. Please enter "admin" under the user name and enter the password that was been set at Netility under password. If did not set before, then please enter the default value as user name: "admin" and nothing under password. (press "Enter").
  - Once the account and password been checked, the server will response with 230 OK to indicate Login succeeded.
  - If entered wrong account and password, the server will response with 530 Not Logged in to indicate Login failed.

- (3) Operation commands as followings:

-ls: This command is to request server to list up all the file and sub file under current Menu.

User may finds out the firmware version of the NetAgent UPS of its IP.

-put<client's file route>: This command is to ask the client to copy its specific file route to the Server point. User may use this method to upload the latest firmware to the remote NetAgent

-quit: This command is to allow the user to logout with the current username account as well as close the connection of FTP.

For example: The picture below is to upload the latest NetAgent firmware file (c:\work\netagent\prjs\nag\2.32.DK520.bin ) which is in this computer to the NetAgent UPS with IP address of 192.168.50.179

```
C:\WINDOWS\System32\ftp.exe
Connected to 192.168.50.179.
220 Service ready for new user
User (192.168.50.179:(none)): admin
331 need password
Password:
230 OK
ftp> ls
200 Port command successful.
150 Opening ASCII mode data connection for file list.
2.32.DK520.bin
226 Transfer complete.
ftp: 16 bytes received in 0.00Seconds 16000.00Kbytes/sec.
ftp>
ftp> put c:\work\netagent\prjs\nag\2.32.DK520.bin
200 Port command successful.
150 Opening data connection for 2.32.DK520.bin
226 file received ok.
ftp: 1040384 bytes sent in 3.28Seconds 317.00Kbytes/sec.
ftp> quit
same version new type OK
```

### 3. Use IE browser to update (suitable for BK,CK,DK,BP,CP,DP version)

This method is to enter the account, password and IP address of the NetAgent UPS which the user wish to update under the website column. Once entered, user may see the current firmware version, and then please copy the latest firmware to here to complete the updating process.

Two method of entering:

- (1) **ftp://admin:password@192.168.50.179**

Again, the password here is the one been set at Netility, if did not set anything before, then enter NetAgent's default value as:

Account: admin

Neglect password (ftp://admin:@192.168.50.179)

- (2) **ftp://192.168.50.179/** , when using this method to enter, the follow error message will be show. At this moment, select "**Enter Identity**" at the top left corner of file menu. Then enter admin as account name and password to re-enter again.

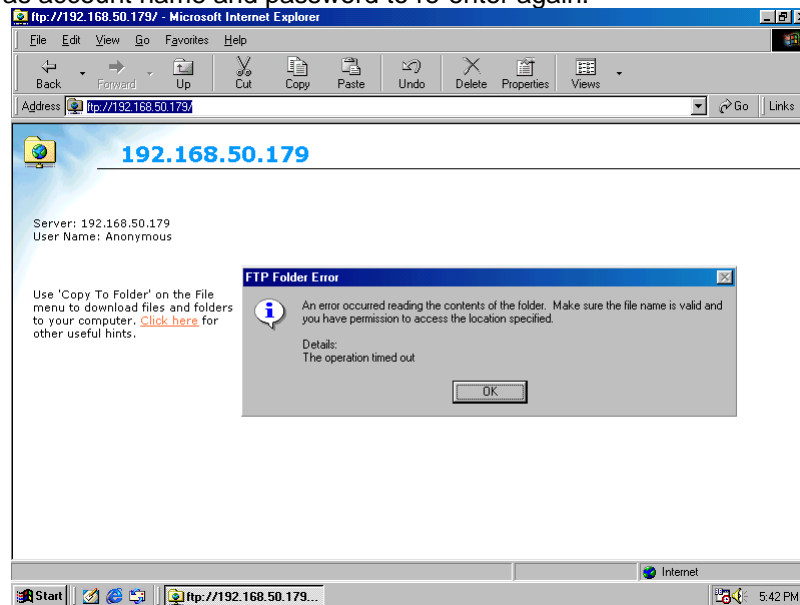

Once the connection been established, the following window will be display. Then the user may transfer the latest firmware to here for the replacement in order to complete the updating steps.

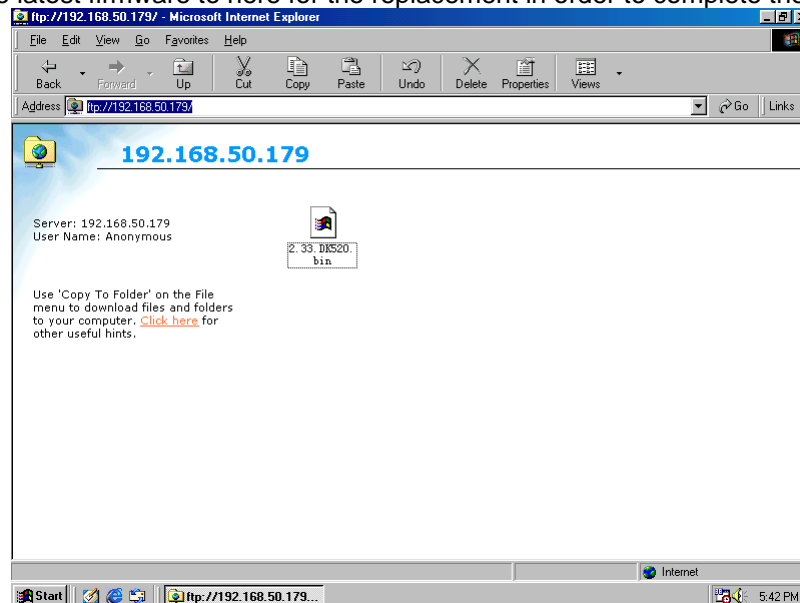

## Appendix B -3 Ports NetAgent II with SMS Modem

### BP506 & SMS MODEM Hardware Installation :

1:

- A : GSM MODEM。
- B : GSM MODEM Adaptor 。
- C : NetAgent BP506。
- D : GSM MODEM Cable。
- E : RS232 to RJ45 Cable。

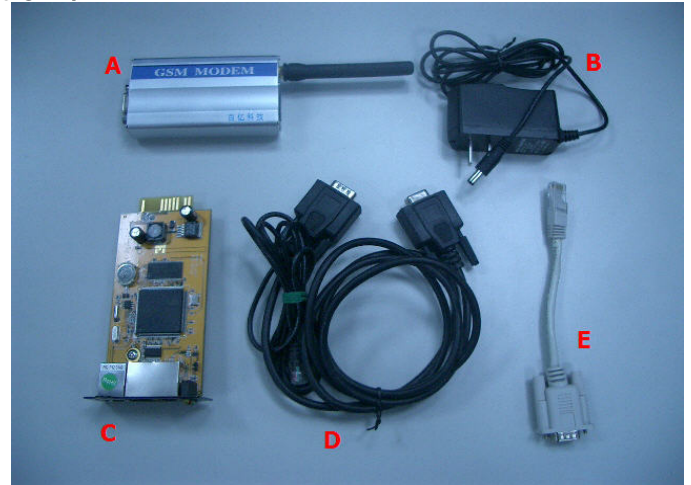

2 : How hardware should be connected



3 : Before use GSM MODEM, insert SIM

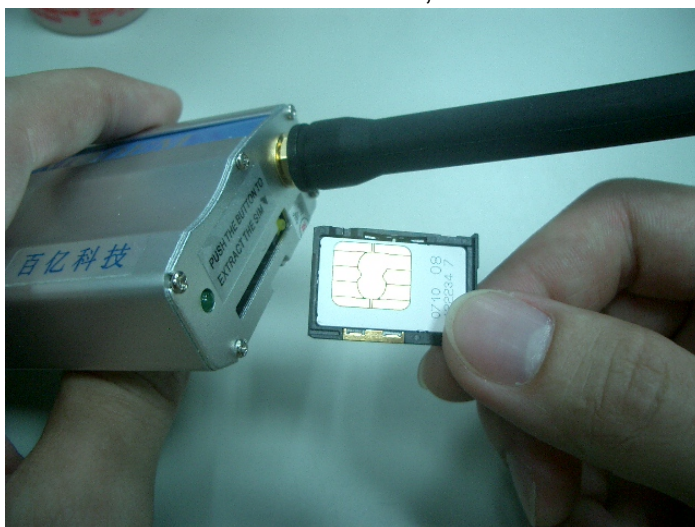

4 : Once card inserted, Modem would detects if such SIM card has password and the signal with its ISP.  
If Led flashes every second continuously, there is no signal been received. OR, SIM

card has password, invalid password.

If such conditions happens, please unplug&plug the power on Modem and it shall ready SIM again.

If Led doesn't flash continuously (once every 8 seconds), then Modem is working properly



## BP506 Modem Configuration :

### 1、BP506 Modem

2.Modem communication Type→Select SMS

3.SMS Communication→Select GPRS

4.Enter SIM Card PIN(leave blank if none)。

5.Click on Apply。

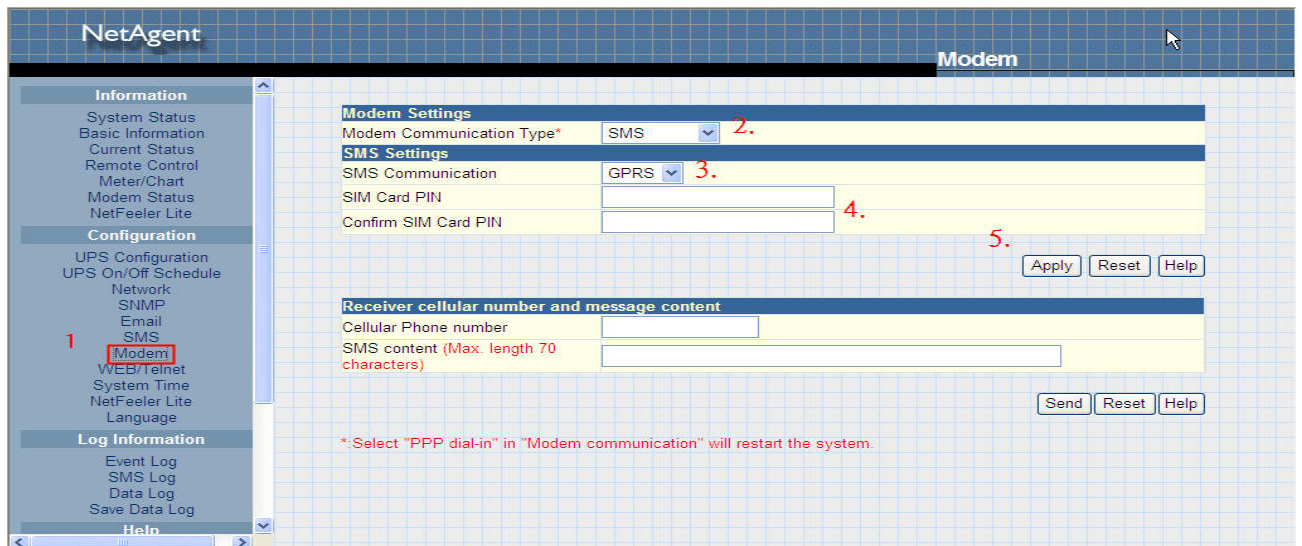

5: Under Modem status of BP506 webpage, it indicates the status of Modem

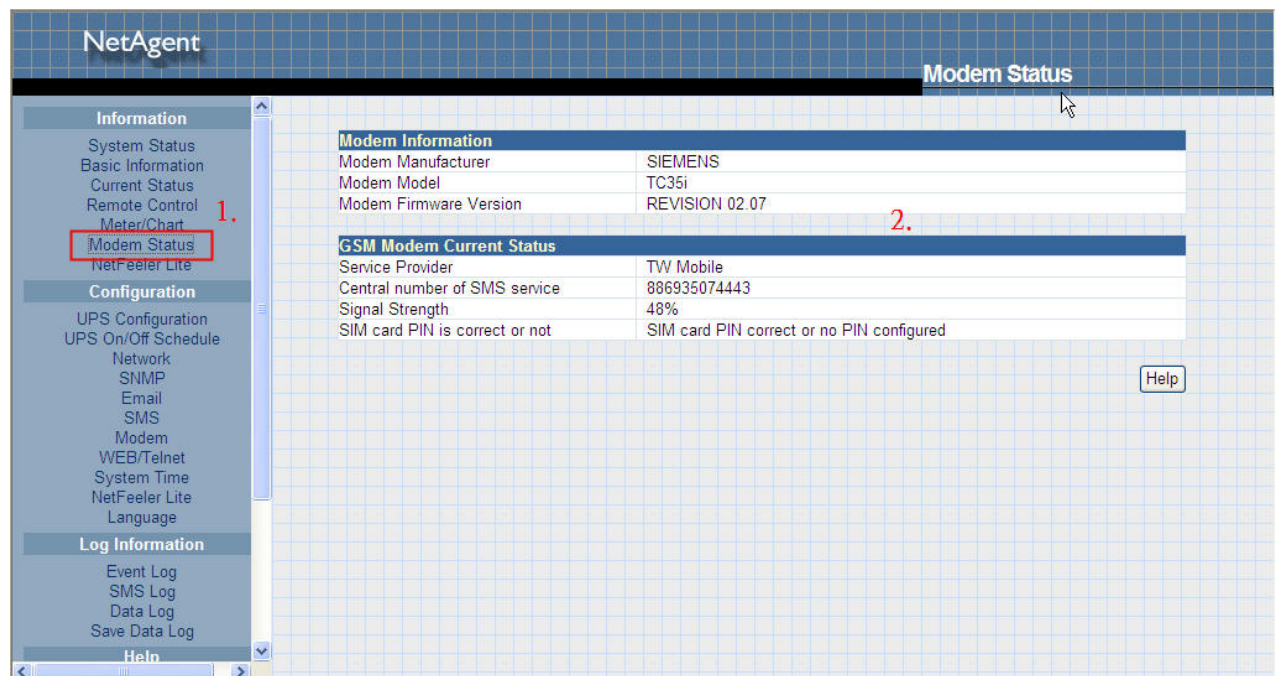

## BP506 SMSConfiguration :

BP506→Configuration→1.SMS

2.Select Local Modem

3.Enter BP506's username and password(leave none leave blank)。

4.Enter Mobile number。

5.Select events to send。

6.Click on Apply。

1 :

## Appendix C –SMS Server with SMS Modme

### GPRS MODEM Installation :

1. Insert Sim card



2. Connect DC adaptor to GPRS modem as well serial cable provided to PC com port

1



2



3



※NOTE : Please make sure there is no conflict port with the GPRS modem

### SMS SERVER Software Installation :

1. Click on exe for installation

1 :

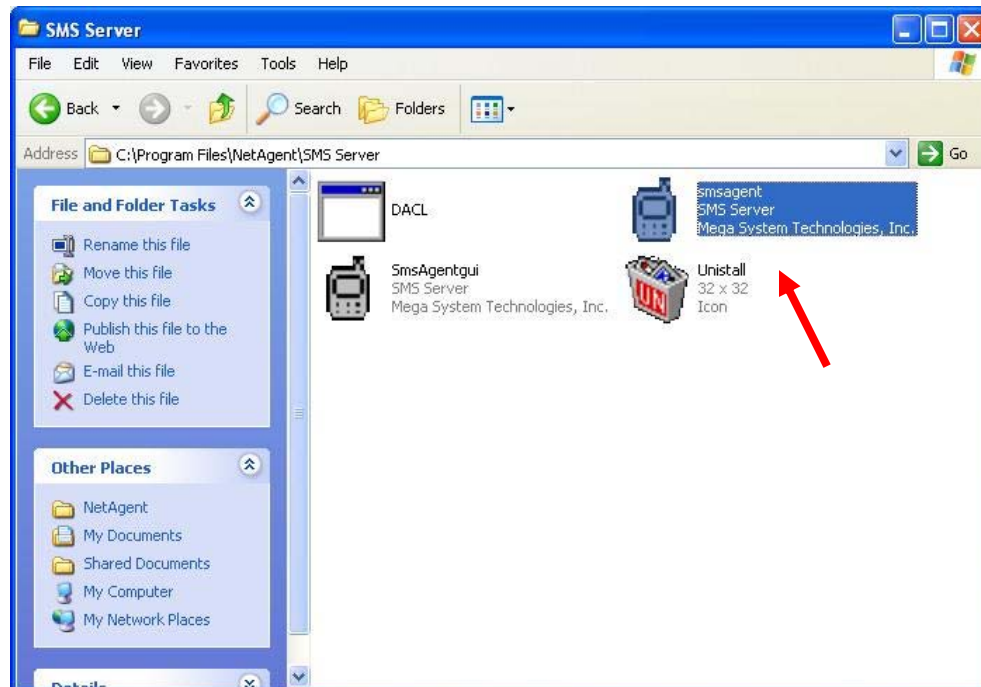

2 : Once installed, the icon would appear on the tool bar



3 : Right click on the SMS server icon and check modem status

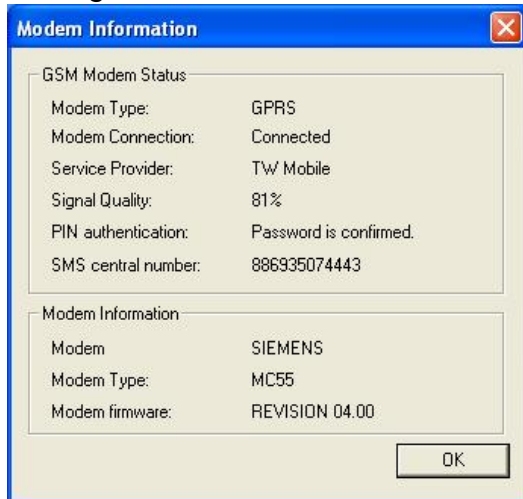

## 2、 SMS Server Software Configuration

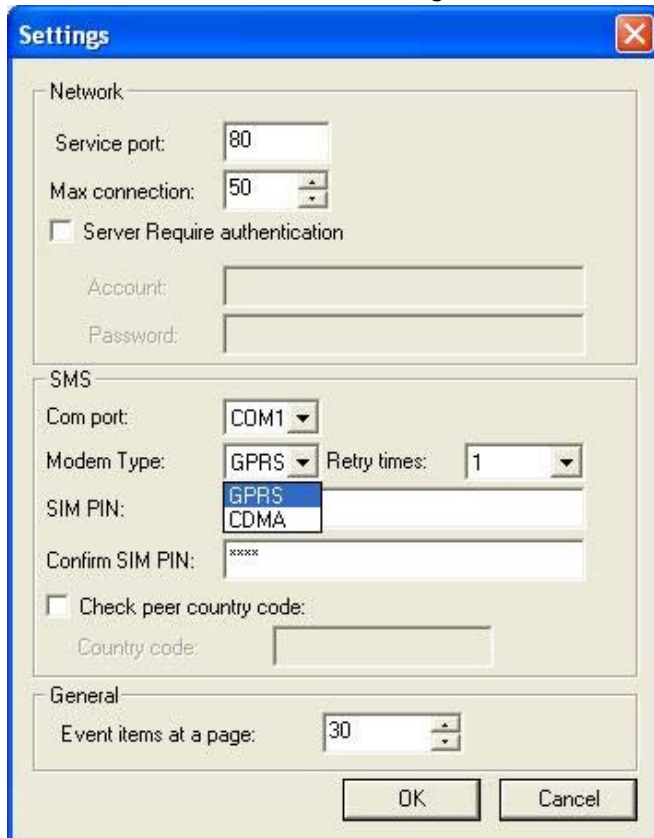



### 3、 NetAgent sends SMS via modem :

1. Click on SMS in the NetAgent Webpage

2. Enter the SMS server's IP

Service Port : NetAgent & SMS Server port that use for local connection

Service account : Account authentication for sending SMS (Leave blank if no such setting)。

Service password : Password authentication for sending SMS (Leave blank if no such setting)。

To send SMS when event occurs : 『YES』 OR 『NO』

3. Enter mobile number to receive event by SMS

4. Select the event that needs to be send

5. Click Apply。

UPS Agent(My Office) - Microsoft Internet Explorer

檔案(F) 編輯(E) 檢視(V) 我的最愛(A) 工具(T) 說明(H)

上一頁 搜尋 我的最愛 移至

網址(D) http://192.168.0.185/

## NetAgent

### SMS

**Information**

**Configuration**

- UPS Configuration
- UPS On/Off Schedule
- Network
- SNMP
- Email
- SMS** (1)
- Modem
- WEB/Telnet
- System Time
- NetFeeler Lite
- Language

**Log Information**

**Help**

**SMS Settings** (2)

Send SMS When Event Occurs: Disable

SMS Server: 192.168.0.1

SMS Server Port: 80

Account Name: [ ]

Password: [ ]

Sending test SMS: [ ] Test SMS

Receiver cellular number(for Event Log)	Events
Cellular Phone number 1	Select (4)
Cellular Phone number 2	Select
Cellular Phone number 3	Select
Cellular Phone number 4	Select
Cellular Phone number 5	Select
Cellular Phone number 6	Select
Cellular Phone number 7	Select
Cellular Phone number 8	Select

Apply Reset Help