



Vault Series

**True On Line,
Double Conversion
Uninterruptible Power Supply**

**USER MANUAL
FOR MODELS:
4000VA - 20000VA**

Table of Contents

Section	Page
1.Introduction	7
2.System Description	7
2.1 General Description.....	7
2.2 System Configuration.....	8
3.Safety Information	9
4.Storage	9
5.Installation	10
5.1 Environment.....	10
5.2 AC Power and Load Connections.....	10
5.3 RearPanelViews.....	22
5.3.a Tower Models - 4k / 5kVA Rear Panel Views.....	22
5.3.b Tower Models - 6kVA Rear Panel Views	23
5.3.c Tower Models 8k / 10kVA Rear Panel Views.....	24
5.3.d Tower Models12kVA RearPanelView.....	25
5.3.e Tower Models 15k / 20kVA Rear Panel Views.....	26
5.3.f Rack Mount Models 4k/5k/6k/8k/10k/12kVAREar Panel Views.....	27
5.4 Connecting an Extended Run Time Battery Pack.....	28
5.5 FactoryDefaultSettings.....	28
6.Communication Interface and Alarm Connections	28
6.1 Overview.....	28
6.2 Connecting the UPS to a Computer.....	28
6.3 RS-232 Interface Port.....	29
6.4 USB Port.....	29
6.5 EPO (Emergency PowerOff) Port.....	29
6.6 Network Transient Protector.....	29
6.7 Load Segments.....	29
7.Operational Instructions	30
7.1 Starting Up and Shutting Down the UPS.....	30
7.2 Push-button Operations.....	30
7.3 Control Panel Indicators.....	31
7.4 LCD Panel Display Modes.....	31
7.5 Manual UPS or Battery Test.....	33
7.6 Sense Mode – Normal and Generator Waveforms.....	34
7.7 AudibleAlarms.....	34
7.8 Troubleshooting.....	35
8.Maintenance	36
8.1 Battery Replacement.....	36
9.Specifications	38
10.Warranties	42

CISPR 22

NOTICE: Pursuant to CISPR 22 rules, this product has been tested and thereby complies with the conditions of a class C2 (6KVA and 10KVA) and Class A digital device, which have been established for offering sufficient protection against dangerous interference for installation in a residential area. Installation and use of the equipment should comply with the instructions provided in order to avoid such interference due to the amount of radio frequency energy that is radiated and generated by the equipment. In spite of this, we cannot assure that a certain amount of interference may not occur in some installations. If, by turning on and off, it can be deduced that your radio or television reception is found to be influenced by harmful interference from the equipment, it is recommended to use one of the following preventive measures:

1. Place the receiving antenna in a separate location or orientation.
2. Ensure a greater distance is achieved between the receiver and the equipment.
3. Ensure that your equipment is connected to an outlet on a separate circuit than the receiver.
4. Contact a technician experienced with radio and TV or a dealer for further assistance.

Declaration of Conformity Request

Units labeled with a CE mark comply with the following standards and directives:

1. Harmonic Standards: EN 50091-1-1 and EN 50091-2, EN 62040-1, EN 62040-2 (6KVA and 10KVA).
2. EU Directives: 73/23/EEC, Council Directive on equipment designed for use within certain voltage limits. EU Directives 2014/35/EU, 2014/30/EU (6KVA and 10KVA).

93/68/EEC, Amending Directive and 73/23/EEC

89/336/EEC, Council Directive relating to electromagnetic compatibility

92/31/EEC, Amending Directive 89/336/EEC relating to EMC

The EC Declaration of Conformity is available upon request for products with a CE mark.



IMPORTANT SAFETY INSTRUCTIONS SAVE THESE INSTRUCTIONS



1. This manual contains important instructions that should be followed during Installation and Maintenance of the UPS and Batteries.
2. **CAUTION (UPS with Internal Batteries):** Risk of electric shock - Hazardous live parts inside this unit are energized from the battery supply even when the input AC power is disconnected.
3. **CAUTION (No User Serviceable Parts):** Risk of electric shock, do not remove cover. No user serviceable parts inside. Refer servicing to qualified service personnel.
4. **CAUTION (Non-isolated Battery Supply):** Risk of electric shock, battery circuit is not isolated from AC input / output; hazardous voltage may exist between battery terminals and ground. Test before touching.
5. **WARNING (Fuses):** To reduce the risk of fire, replace only with the same type and rating of fuse.
6. **WARNING:** Intended for installation in a controlled environment. The maximum ambient temperature is 40°C.
7. **CAUTION:** Do not open or damage the battery, electrolyte may be released which is harmful to the skin and eyes.
8. **CAUTION:** A battery can present a risk of electric shock and high short circuit current. The following precautions should be taken when working with batteries:
 - a. Remove watches, rings and other jewelry or metal objects.
 - b. Use only tools with insulated handles.
 - c. Wear rubber gloves and boots.
 - d. Do not lay tools or metal parts on top of batteries.
 - e. Disconnect charging source prior to connecting or disconnecting battery terminals.
9. Do not dispose of batteries in a fire, as they may explode.
10. To reduce the risk of electric shock, disconnect the UPS from the AC input power supply before installing a communication interface cable. Reconnect the power cord only after communication interconnections have been made.
11. Battery replacement should be performed or supervised by personnel with knowledge of batteries. Keep unauthorized personnel away from the batteries.
12. **CAUTION:** To reduce risk of fire, connect only to a circuit provided values as shown in table below, maximum branch circuit over current protection in accordance with the National Electric Code, ANSI/NFPA 70". An AC output disconnect shall be provided by others. Table 3a for UL models and Table 3b for CE models.
CAUTION: This UPS is not applicable for motors, hair dryers, speakers, and fluorescent lamps.

The instructions contained within this safety manual are extremely important and should be closely followed at all times during installation and follow-up maintenance of the UPS and battery.



CAUTION

The unit contains dangerous voltage levels. If the UPS is on, but not connected to an AC power supply, the unit's outlets may still be energized with voltage due to the presence of an internal power source, i.e. the battery.

The unit should be installed indoors in an area free of electrically-conductive contaminants.

The unit should be installed in a temperature and humidity controlled environment in order to reduce the risk of electric shock.

Only the power cord that is supplied with the unit should be used to connect it to the AC power supply. The equipment should also be located as close as possible to the AC supply.

Replacing and maintenance should only be carried out by qualified service personnel with the exception of battery replacement.

Before carrying out battery or fuse replacement or shipping the unit, first ensure that the unit is turned off completely and all cables are disconnected.

For additional safety instructions, please use the Safety Manual as reference.

Symbols

The following symbols warn of precautions and provide directions or instruction regarding the unit:



RISK OF ELECTRIC SHOCK - Indicates that there is a risk of electric shock.



CAUTION: REFER TO OPERATOR'S MANUAL - Indicates that the operator's manual should be referred to for additional information, such as operating and maintenance instructions.



SAFE GROUNDING TERMINAL - Indicates primary safe ground.



LOAD ON/OFF - Indicates that the associated push-button turns the unit and its output on or off.



RJ-45 CONNECTOR - Indicates that this connector provides network interface connections and that telephone or telecommunications equipment should NOT be plugged into it.



DISPOSAL - Indicates that the UPS and its batteries should be disposed of in the correct manner since the batteries are of the lead-acid type. It is recommended that the batteries be recycled.

1. Introduction

The information provided in this manual refers to our single phase, 4000VA through 20000VA, true on-line uninterruptible power supplies. It covers basic functions, operating and installation instructions, cautionary notes and detail on how to ship, store and handle them. Installation must be carried out in accordance with this manual as well as local electrical regulations and should only be performed by qualified personnel to avoid the risk of electric shock or damage to the unit. Any warranties covering these units will become void if the unit is found to have been incorrectly connected or tampered with.

2. System Description

2.1 General description

Configured as a true, on-line double conversion unit, this UPS is able to supply seamless, pure single-phase AC power to critical loads while keeping the batteries charged continuously. In the event that a power interruption lasts longer than the UPS's backup time capability, it will shut down to avoid complete battery discharge. As soon as AC power is restored, the UPS will automatically restart and begin recharging the batteries.

A block diagram of the UPS infrastructure is shown in Fig. 1:

- An input filter reduces transients, noise and surges on the incoming AC supply
- AC power is rectified and regulated by the rectifier supplying power to the inverter and battery converter. Battery voltage and charge is maintained at optimum levels.
- DC power is converted to AC power by the inverter which passes it on to the load.
- Power is supplied from the battery during a power failure or deep voltage sag.
- The converter increases voltage to an appropriate level for the inverter.
- An integral automatic bypass switch seamlessly circumvents the electronics in the event of a component failure ensuring continuous power to the load.

Fig. 1

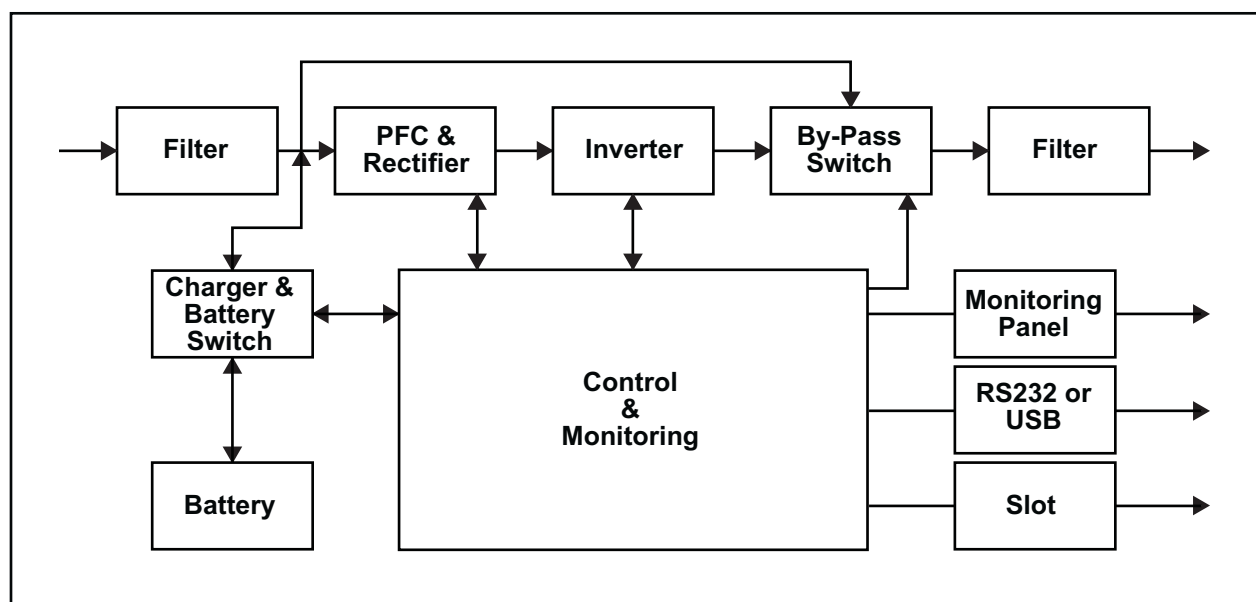

Efficiency Optimizer

The Efficiency Optimizer is a unique feature that reduces long-term cost of ownership by minimizing power loss and reducing power consumption thereby making the entire system extremely efficient. Simply put, the UPS automatically alternates between bypass and on-line modes depending upon the condition of the incoming AC power. The UPS will remain in on-line mode during any type of power disturbance but unlike traditional on-line systems, will switch to bypass mode when AC power is within acceptable limits in order to achieve greatest efficiency. Power disturbances can be detected in less than a second, and on-line mode reactivated immediately. Switching back to online mode occurs when the input voltage is outside of $\pm 10\%$ of nominal ($\pm 15\%$ selectable), when input frequency is outside of $\pm 3\text{Hz}$ or when no AC power is present.

While the default operation is on-line mode, bypass can be activated via the LCD panel. The Efficiency Optimizer can be de-activated and the unit can be run permanently in on-line mode if preferred.

Free Run Mode

Free run mode is defined as being when the output frequency is fixed and not synchronized with the input frequency. When activated, the output frequency regulation is automatically set to either 50 or 60 Hz and is regulated to within $\pm 0.25\text{Hz}$. Please refer to Chapter 7 for instructions on how to activate bypass mode while the UPS is in free run mode.

Diagnostic tests

Whenever the UPS is turned on, a diagnostic test to check the status of the internal electronics and battery is activated. Any errors or faults are displayed on the LCD panel.

An advanced battery management system continuously monitors the condition of the batteries and notifies the user in advance if replacement is needed.

In addition, a battery discharge test is performed every 30 days in normal mode operation, and any problems are displayed on the LCD panel.

Diagnostic tests can be performed manually from the LCD panel at any time, except during the first 24 hours after startup while the UPS is in charging mode (see Chapter 7).

2.2 System Configuration and Sizing

The internal electronics of the UPS plus the internal battery or batteries constitute the system. Please make sure that the following factors have been taken into consideration:

1. The total demand of the protected load determines the UPS power (VA) requirements. Allow some margin or headroom for future expansion or power requirement calculation inaccuracies.
2. Aside from power (VA) requirements, backup time needs to be considered. If the power consumed by the load is less than the nominal power rating of the UPS, then the actual backup time will be longer.
3. The following options are available, depending on application and load requirements:
 - a. External Battery Packs (EBP's) for extended run-times
 - b. Input / Output transformer cabinets
 - c. Maintenance bypass switches
 - d. Connectivity and control options (e.g. relay card, SNMP/WEB card)

Table 1

Model	Backup time with internal batteries	Recharge time to 90% capacity
UPS 10000 VA	4~5min	4 hours

3. Safety Information

PLEASE READ THIS SECTION TO AVOID RISK OF SHOCK OR OTHER HAZARDOUS SITUATIONS.

1. Please handle the unit with extreme caution since the batteries contain large amounts of energy. Always store the unit in the orientation marked on the packaging.
2. Take extra care to avoid dropping the unit.
3. If flammable substances are present or if any gases or fumes are being emitted or if there is no ventilation in the place of storage or installation, a safety hazard exists and neither the unit or the extended battery packs should be operated in these environments.
4. The instructions in this manual detail how to install the UPS safely and correctly. Please read it thoroughly and keep this manual for future reference.



WARNING! It is strongly advised that the UPS NOT be opened by anyone other than suitably qualified personnel. Dangerously high voltages are present within, regardless of whether the UPS is connected or not. In addition, the unit's output receptacles may contain live AC voltage even when not connected to the AC power supply since it contains its own energy source, (i.e. batteries).

User Allowable Operations

The only UPS-related operations that the user is allowed to perform are:

1. Turning the unit on and off.
2. Operating the user interface (function push-buttons and LCD panel).
3. Connecting data interface cables

All such operations are to be performed exactly as instructed in this manual. Any deviation from these instructions may prove hazardous and even fatal or may cause damage to the unit.

4. Storage

Please adhere to the following storage instructions if the UPS is not to be installed shortly after delivery:

1. Store the unit as is in its original packing and shipping container.
2. Store the UPS covered, upright and in a cool, dry location, with its battery fully charged.
3. Before storing, charge the UPS for at least 8 hours.
4. Ensure that the equipment is fully protected from wet or damp areas and from moisture.
5. Ensure that the UPS is recharged every 6 months for at least 8 hours in order to maintain battery energy and maximize usable life.
6. For temperature ranges, please refer to "Environmental Specifications" stated in this manual.

5. Installation

5.1 Environment

Ensure that all environmental requirements are met, otherwise the safety of installation personnel and users cannot be guaranteed. In addition, the unit may sustain damage or malfunction.

Please adhere to the following environmental instructions when locating the UPS and EBP's:

1. Avoid temperature and humidity extremes. The optimum operating temperature range is between 59°F and 77°F (+15°C and +25°C).
2. Provide protection against moisture or avoid altogether if possible.
3. Ensure there is at least 12 inches (300mm) behind and 12 inches (300mm) on each side of the UPS for ventilation.
4. Ensure that the front of the UPS remains unobstructed for access to the control panel and LCD display.
5. External Battery Packs must be installed next to or under the UPS.

5.2 AC Power and Load Connections

Vertical and Wall-Mount Installation

Only qualified technicians should carry out installation of this equipment. The installation must further comply with all local legislation and regulations.

Follow all installation and safety instructions very carefully to avoid the existence of a hazardous situation and damage to the UPS and/or loads.

The high voltage and current contained within this equipment can injure or be fatal to personnel and can damage associated equipment.

Various input (and sometimes output) cables are supplied with all models:

1. Ensure that the UPS is disconnected from the AC supply when connecting External Battery Packs.
2. Use the battery cable that is supplied with the External Battery Pack when connecting it to the UPS. Connect the second battery cabinet to the first and so forth, assuming more than one is to be used.
3. Take note of UPS parameters when adding external battery packs and adjust accordingly (see Ch. 7).
4. Connect the input cable to the UPS and connect the other end to a grounded AC power supply. The batteries will automatically begin to charge. Please note that while the UPS may be used immediately, maximum back-up time may not be available until the batteries have been charged for a minimum of 8 hours. See Table 1 for input circuit breaker rating and conductor size.
5. If the unit displays "Site Wiring Fault", have the wiring fault corrected or alternately, disable the related alarm on the UPS.
6. After initial charging is complete, connect the loads to the UPS.
7. Do not connect any load that may overload the UPS such as equipment containing AC electric motors or loads that have a high inrush current.
8. Make computer and/or alarm interface connections according to Chapter 6 of this user manual and that provided with the interface option. These connections are made on the rear panel.
9. Installation is now complete.

Table 2

Wire size	6-8 AWG and 6AWG (10kVA)
Wire Stripping length	8 mm and 14mm (10kVA)
Minimum temperature	60 °C
Wire conductor material	Copper only
Screw Torque	18 lb.-in

Additional Installation Information (for 6000VA ~ 20000VA Models)

1. Ensure that all electrical connections have been correctly implemented for the installation site out.
2. Refer to Table 2 for input and output breaker rating.
3. Isolate and prevent the source from activating. Both input and output circuit breakers (located on the rear of the unit) must be in the "OFF" position.
4. Refer to figure 2 for single cable input connection and figure 3 for dual cable input connection. If installing dual cables, the interconnection jumper (J) shown in figure 2 needs to be removed.
5. If during installation, it cannot be determined that the neutral is grounded or identification of the status of the neutral in the AC supply is unreliable, an additional two pole disconnect device may be necessary in the for the installation.
6. Should the optional Emergency Power Off (EPO) circuit on the rear on the unit be used, the output of the UPS will shut down immediately.

Note: Local safety requirements may require a separate external Emergency Power Off that opens output circuit breakers. Refer to local wiring regulations.

Table 3a

UPS Model	Input Breaker Rating	Output Breaker Rating
6kVA	2P, 250Vac, 40A	2P, 250Vac, 40A
8kVA	2P, 250Vac, 50A	2P, 250Vac, 50A
10kVA	2P, 250Vac, 60A	2P, 250Vac, 60A
12kVA	2P, 250Vac, 70A	2P, 250Vac, 70A

Table 3b

VGD 4k-12k Tower UPS:			
UPS Model	Input Breaker Rating	Output Breaker Rating	Battery Breaker Rating
4kVA	1P, 277Vac, 20A	1P, 125/250VAC, 16A 1P, 125/250VAC, 10A	NA
5kVA (bat*10)	1P, 250Vac, 30A	1P, 125/250VAC, 16A 1P, 125/250VAC, 10A	NA
5kVA (bat*20)	2P, 250Vac, 30A	2P, 250Vac, 30A	NA
6kVA	2P, 250Vac, 30A	2P, 250Vac, 30A	NA
8kVA	2P, 250Vac, 63A	NA	2P, 250Vac, 63A
10kVA	2P, 250Vac, 63A	NA	2P, 250Vac, 63A
12kVA	2P, 250Vac, 63A	NA	2P, 250Vac, 63A
VRM 4k-12k Rack Mount UPS:			
UPS Model	Input Breaker Rating	Output Breaker Rating	Battery Breaker Rating
4kVA	1P, 277Vac, 20A	NA	NA
5kVA (bat*10)	1P, 250Vac, 30A	NA	NA
5kVA (bat*20)	2P, 250Vac, 30A	2P, 250Vac, 30A	NA
6kVA	2P, 250Vac, 30A	2P, 250Vac, 30A	NA
8kVA	1P, 250Vac, 65A	1P, 250Vac, 65A	NA
10kVA	1P, 250Vac, 65A	1P, 250Vac, 65A	NA
12kVA	1P, 250Vac, 65A	1P, 250Vac, 65A	NA

Fig. 2

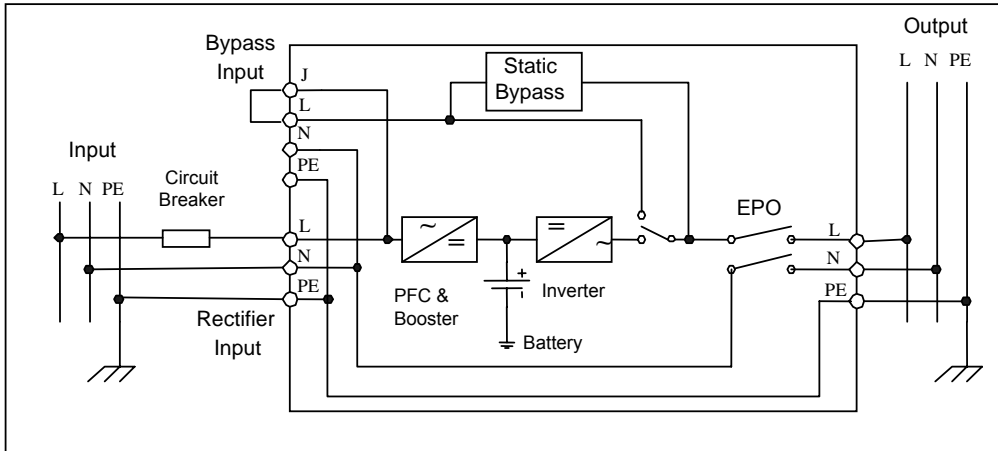
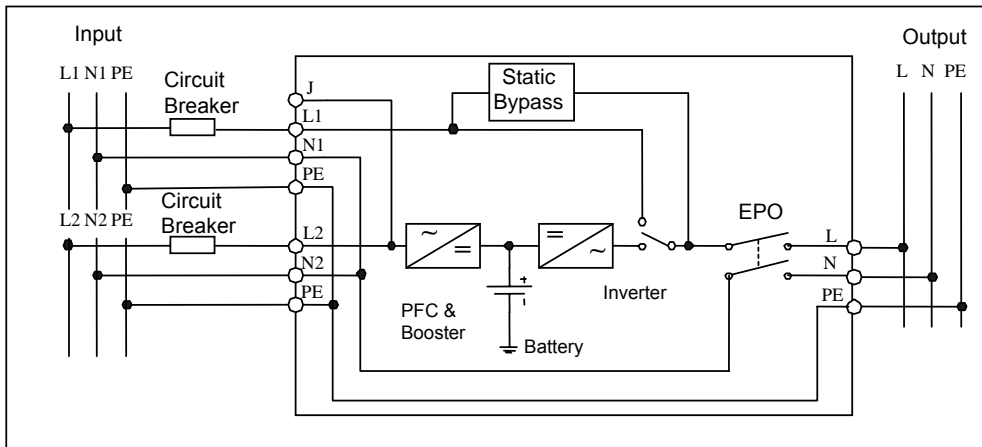
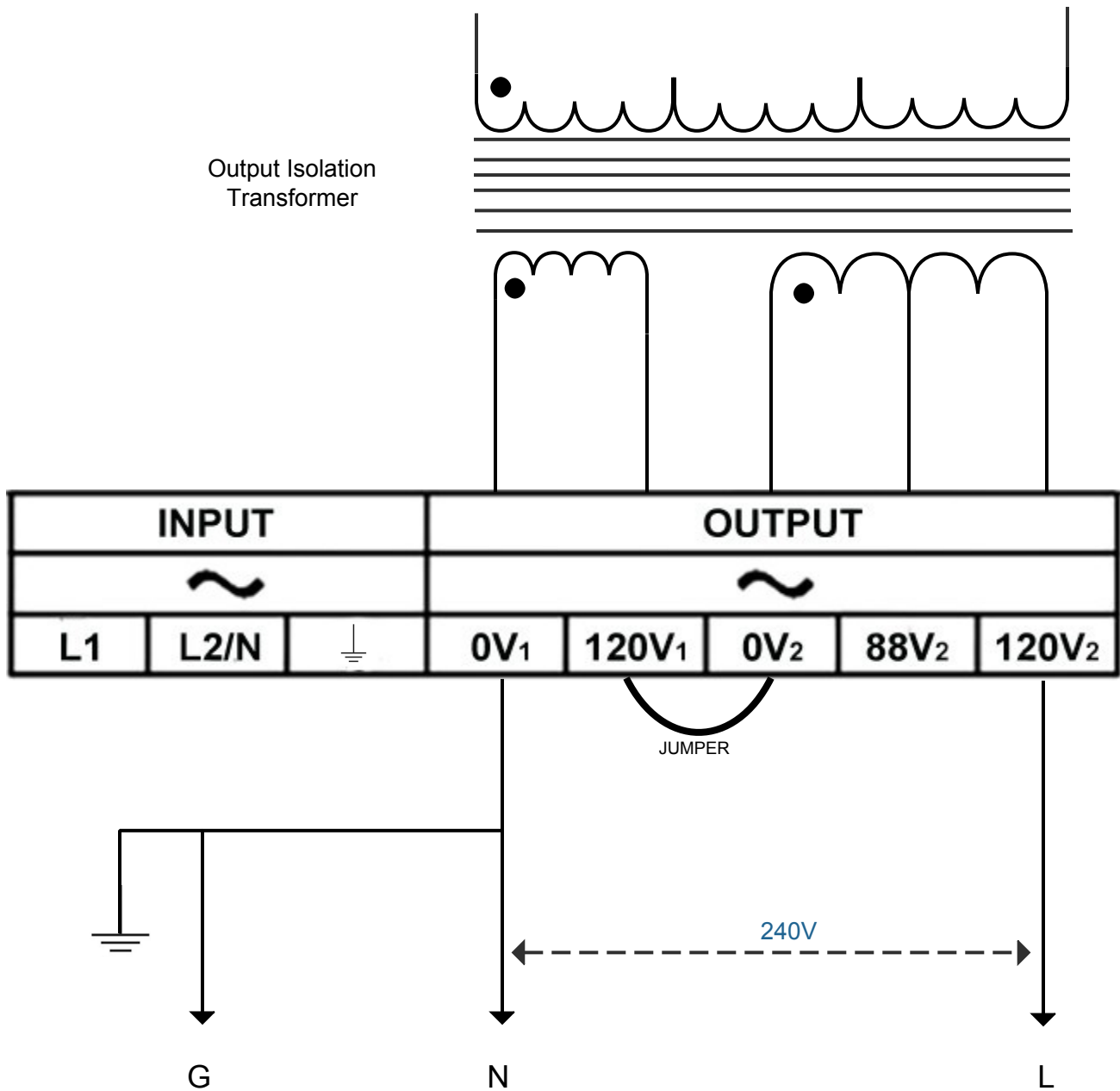

Fig.3



Vault 6kVA to 12KVA Double Conversion UPS
 Output Wiring Diagram
 Output Configuration: 240V Only



Output 240V Only – 100% of the rated output capacity of the UPS.

Vault 6kVA to 12KVA Double Conversion
 UPS Output Wiring Diagram
 Output Configuration: Standard Split-Phase -
 120V and 240V Simultaneously

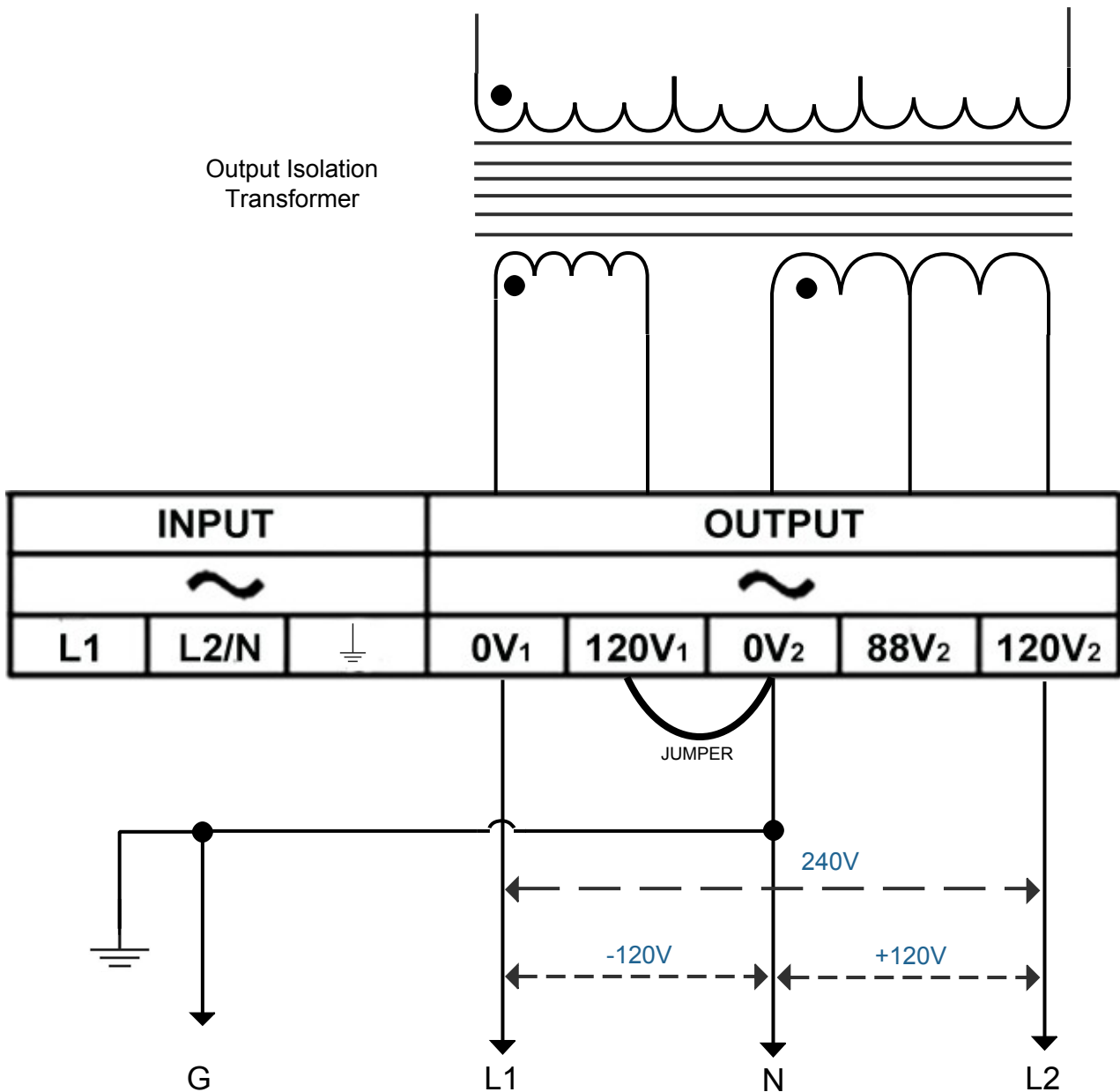

SPLIT PHASE

1. Each of the two 120V circuits can provide half of the rated output capacity of the UPS.
2. The Two 120V AC lines are out of phase with each other by 180 degrees.
2. The 240V circuit alone can provide 100% of the rated output capacity of the UPS.
3. When using the 120V and 240V circuits simultaneously
 - a. No 120V circuit can draw more than half of the rated output capacity of the UPS.
 - b. The combined draw of both 120V and 240V circuits, cannot exceed the rated output capacity of the UPS.

Vault 6kVA to 12KVA Double Conversion UPS
 Output Wiring Diagram
 Output Continuation: 120V Only

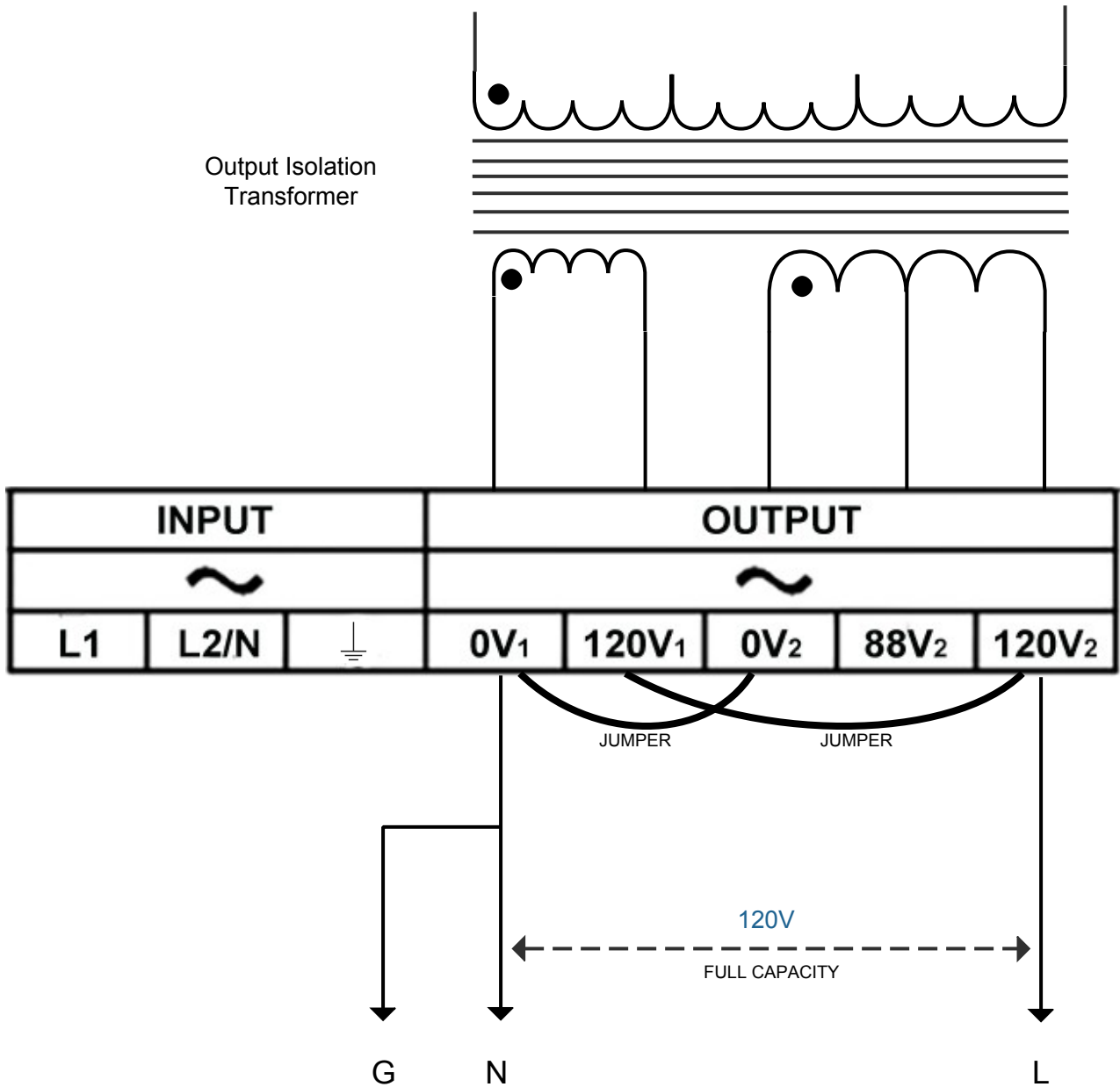

Output 120V Only – 100% of the rated output capacity of the UPS.

Vertical and Wall-Mount Installation

The following diagrams illustrate how to install or mount the UPS (and battery packs when applicable) in either vertical or wall-mount applications:

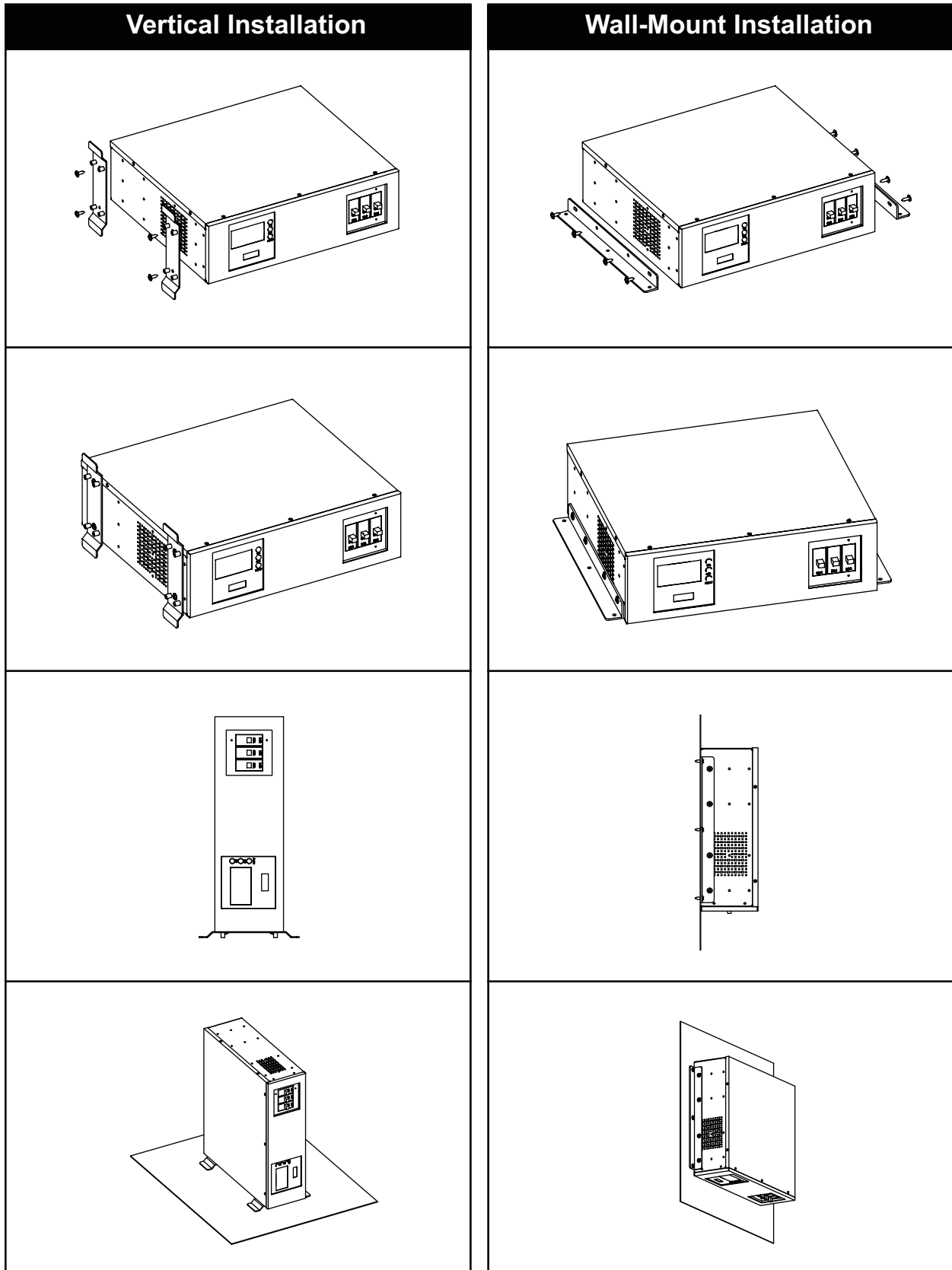

Installation Appendix

Installing the input /output terminals with covers on UPS Module. Screws: M3x8

Step1: Separate the top cover

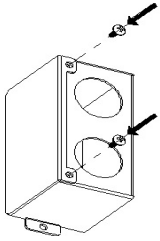

Step 2: Fix the bottom cover on the terminal block.

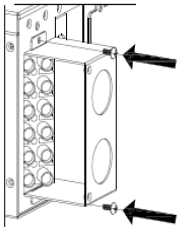

Step 3: Input configure. Insert the input cable.

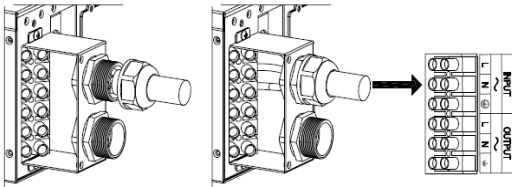

Step 4: Output configure. Insert the output cable.

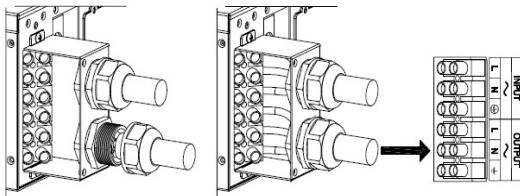

Step 5: Fix the top cover.

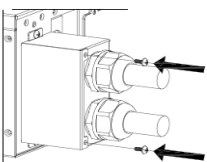

Connecting the UPS to the Battery

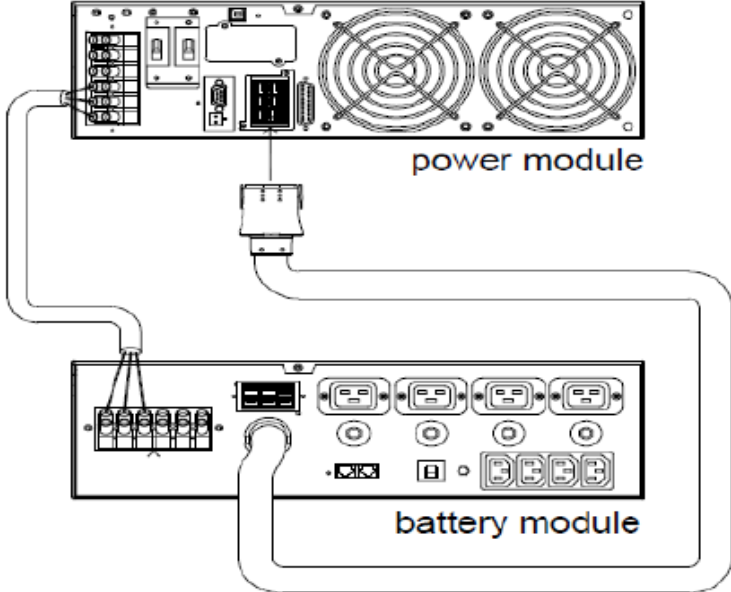
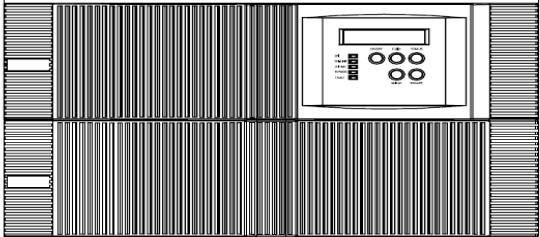

19" Rack-Mount Installation

The following diagrams illustrate how to install or mount the UPS (and battery packs when applicable) in 19" rack-mount applications:

Lower Side Rail Installation

Part Number: RMB-06, 2PCS
Screw: M5*11, 4PCS

The first diagram shows the UPS unit from a three-quarter perspective. The second diagram shows the lower side rails being attached to the front of the rack. The third diagram shows the UPS unit being inserted into the side rails. The fourth diagram shows the UPS unit fully installed in the rack.

Rear Bracket Installation

Part Number: RMB-01, 2PCS
Screw: M5*11, 4PCS

The first diagram shows the UPS unit from a three-quarter perspective. The second diagram shows the rear brackets being attached to the back of the rack. The third diagram shows the UPS unit being inserted into the rear brackets. The fourth diagram shows the UPS unit fully installed in the rack.

Unit Stack Installation

The following diagrams illustrate how to stack the units (and battery packs when applicable):

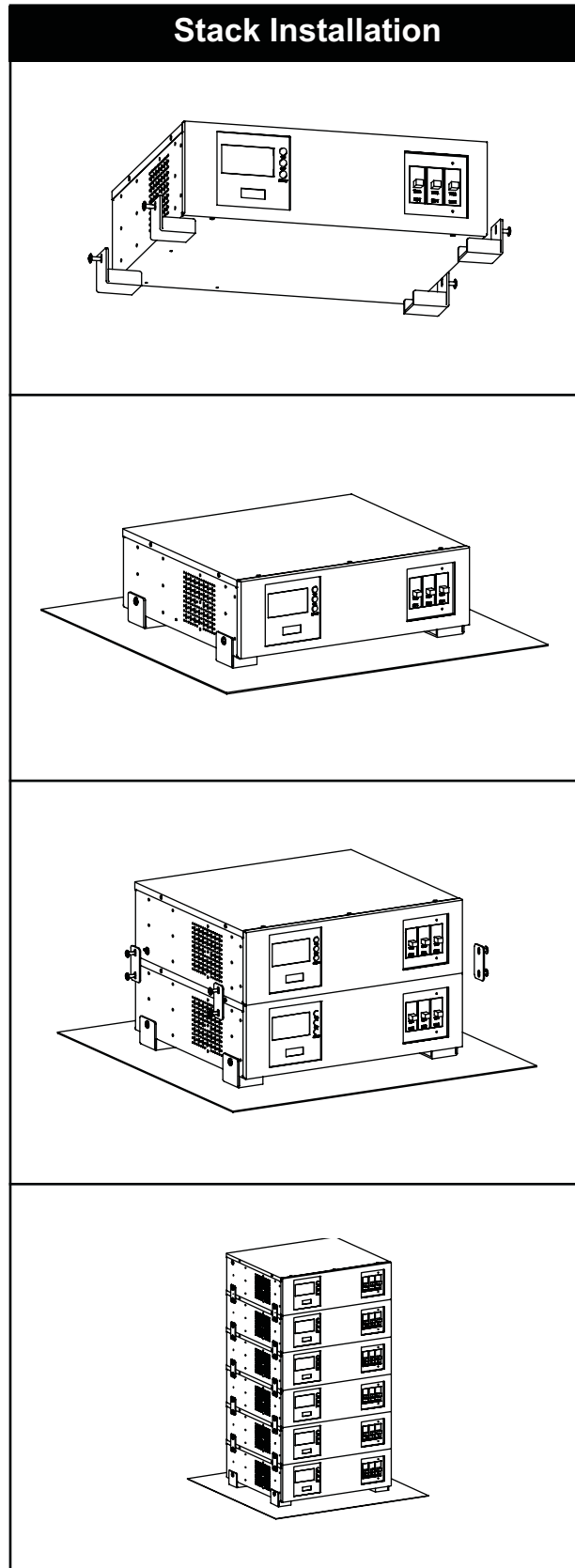

5.3 Rear Panel Views

5.3a Tower Models 4k / 5kVA Rear Panel Views

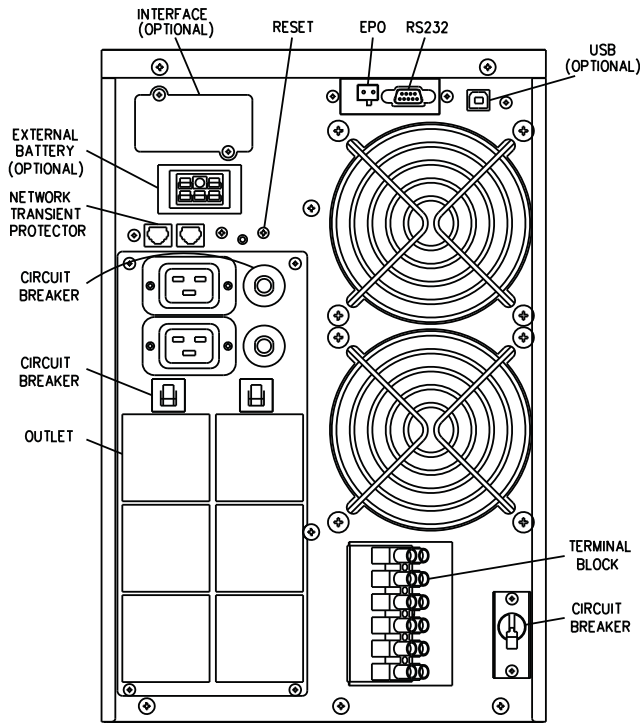

**4kVA REAR PANEL
(230V E/F/G/I Type)**

Rear View 1

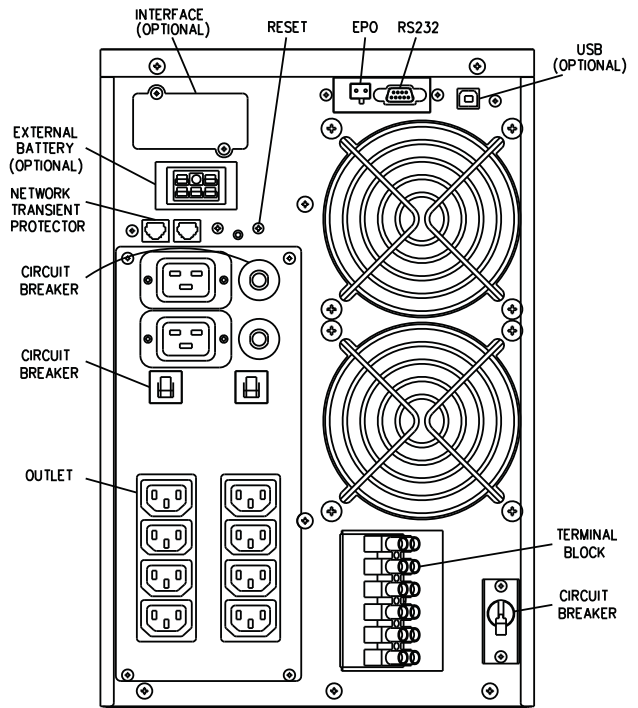

**4kVA REAR PANEL
(230V IEC Type)**

Rear View 2

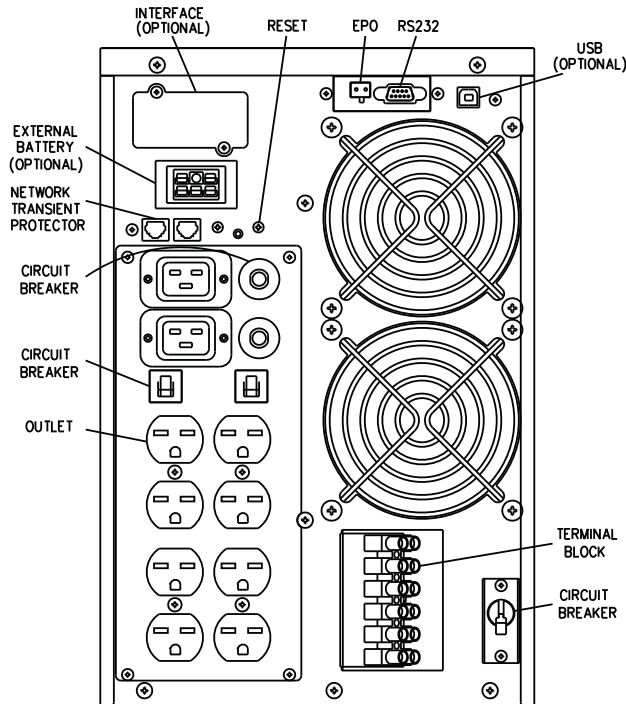

**4kVA REAR PANEL
(230V NEMA Type)**

Rear View 3

VTWE-4000-02 Rear View 1, 2 or 3

VTWE-5000-02 Rear View 1, 2 or 3

Different output receptacle options available

5.3b Tower Models 6kVA Rear Panel Views

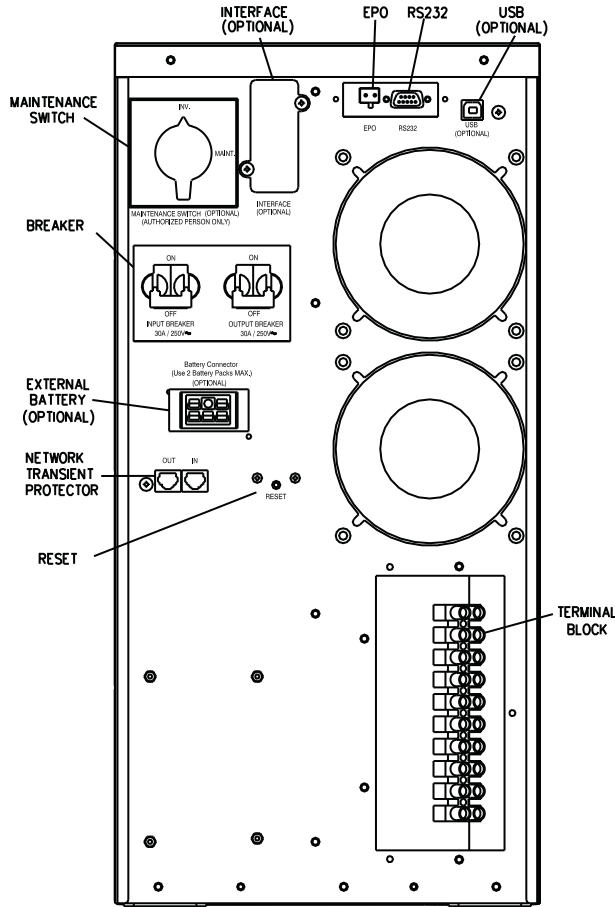

**6kVA REAR PANEL
(without ISO)**

Rear View 4

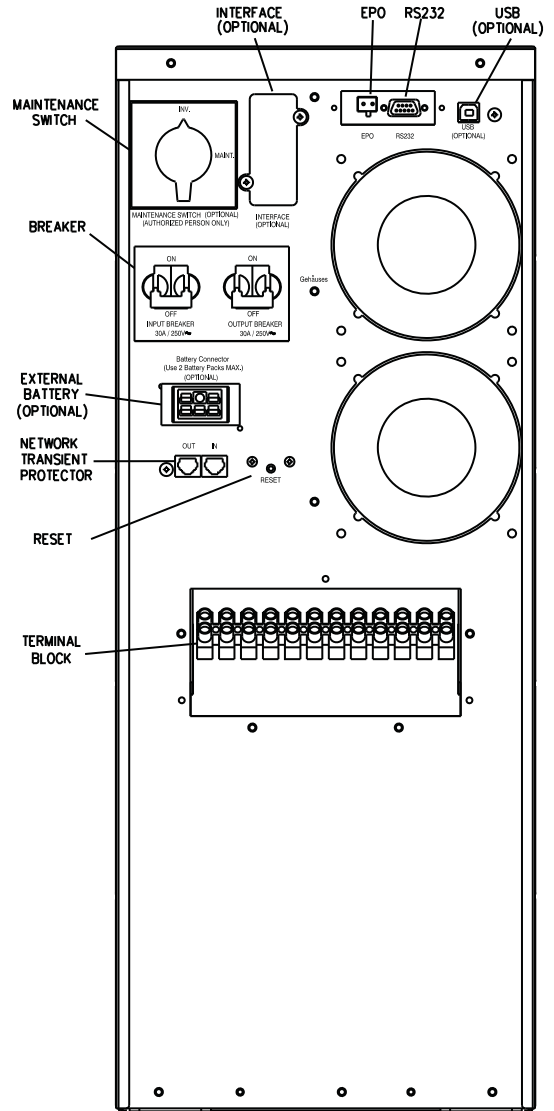

**6kVA REAR PANEL
(with ISO)**

Rear View 5

VTWE-6000-02 Rear View 4 or 5

Different output receptacle options available

5.3c Tower Models 8k / 10kVA Rear Panel Views

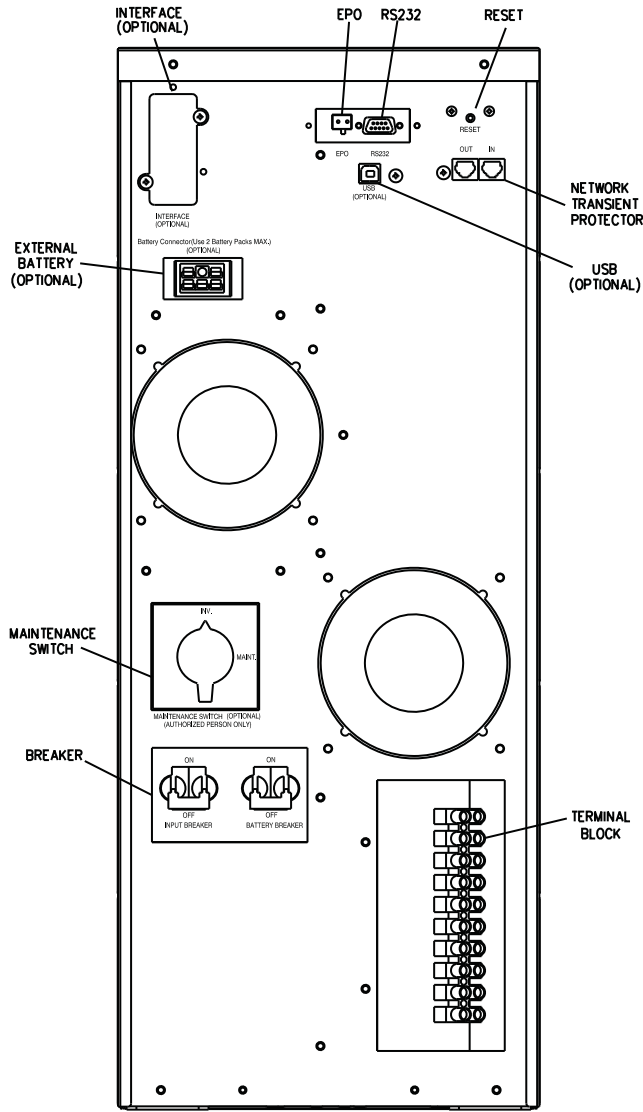

**8/10kVA REAR PANEL
(with ISO)**

Rear View 6

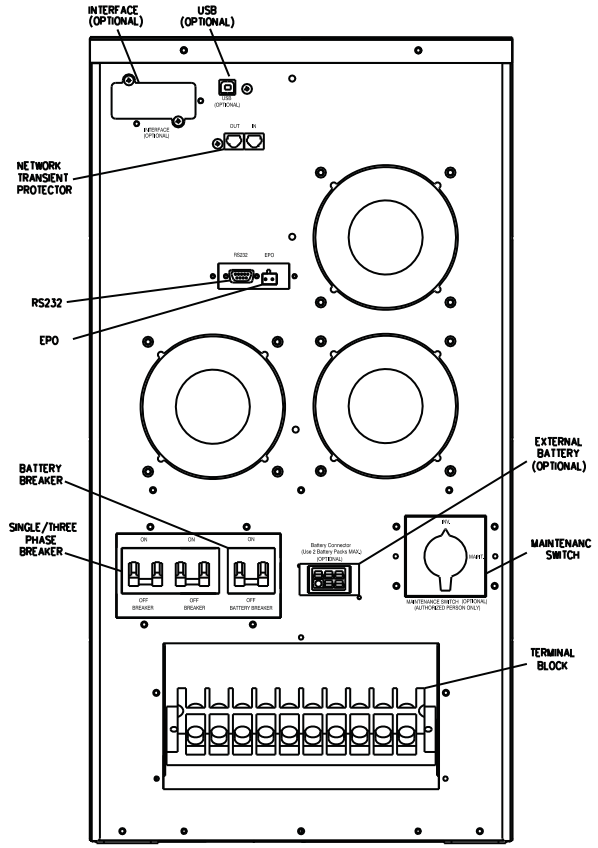

**8/10kVA REAR PANEL
(without ISO)**

Rear View 7

VTWE-8000-02 Rear View 6 or 7

VTWE-10000-02 Rear View 6 or 7

Different output receptacle options available

5.3d Tower Models 12kVA Rear Panel Views

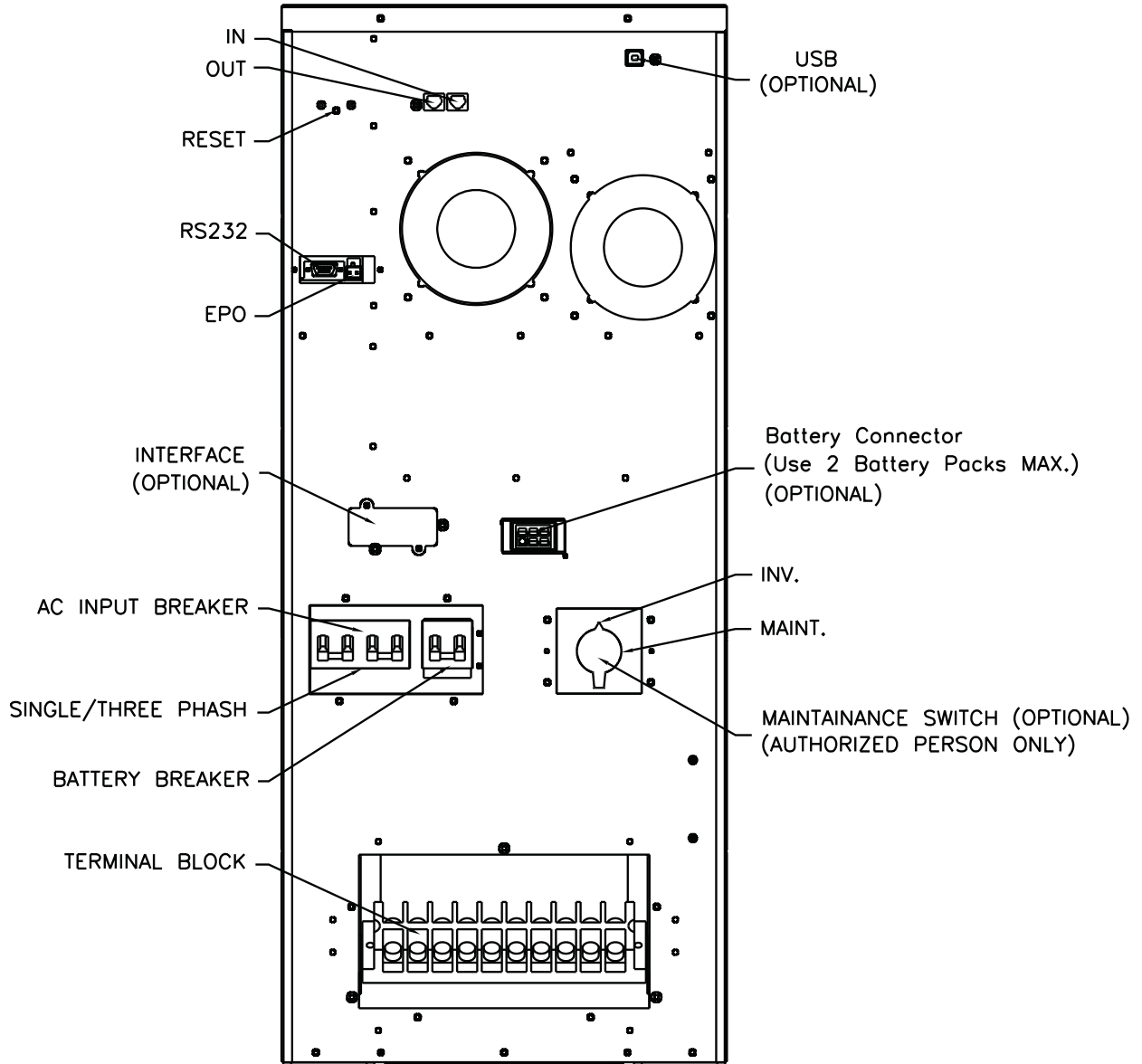

**12KVA REAR PANEL
(with or without ISO)**

Rear View 8

VTWE-12000-02 Rear View 8

Different output receptacle
options available

5.3e Tower Models 15k / 20kVA Rear Panel Views

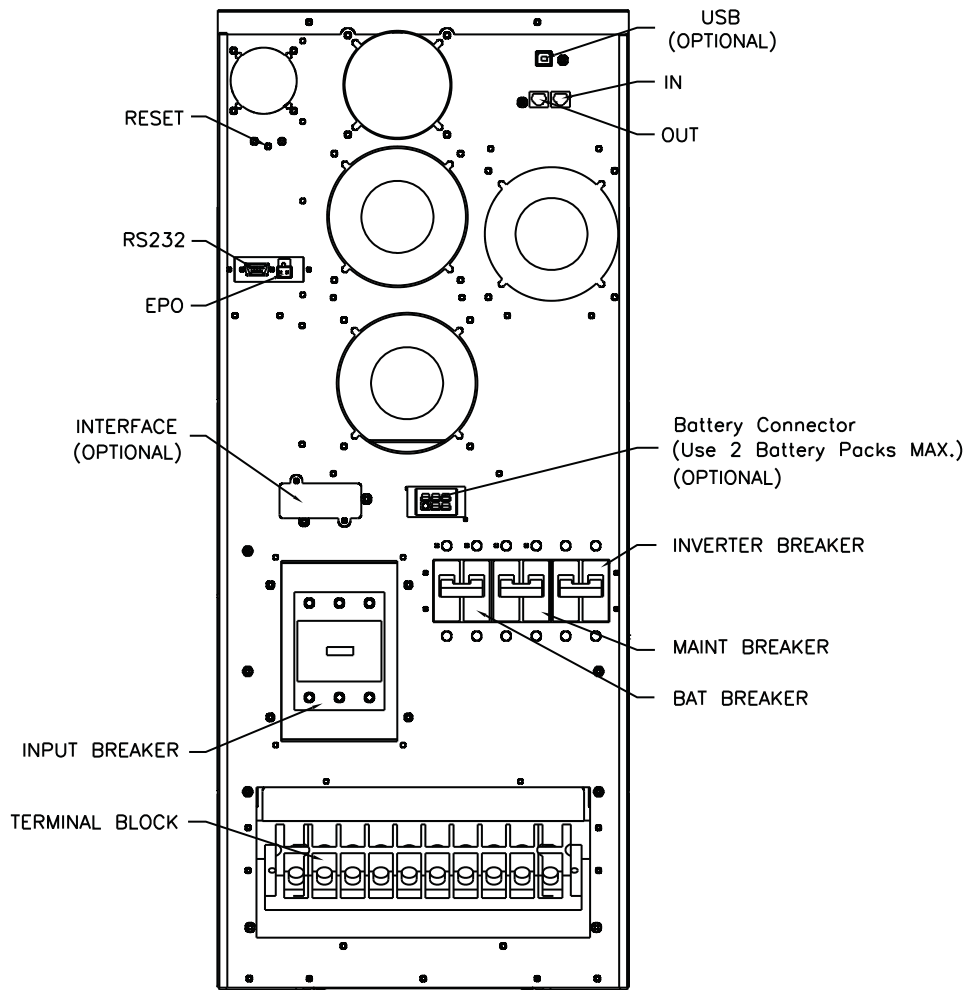

**15/20KVA REAR PANEL
(with or without ISO)**

Rear View 9

VTWE-15000-02 Rear View 9

VTWE-20000-02 Rear View 9

Different output receptacle
options available

5.3f Rack Mount Models 4k / 5k / 6k / 8k / 10k / 12kVA Rear Panel Views

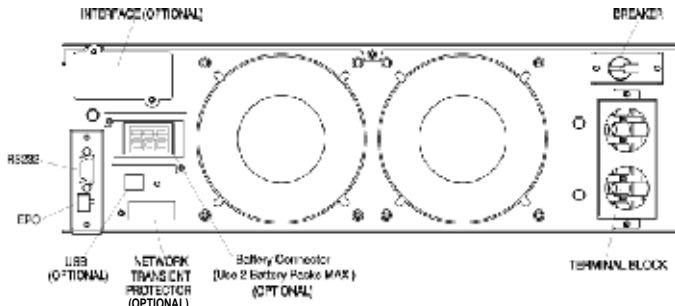

VRTE-4000-02 Rear View 10
 VRTE-5000-02 Rear View 10

4/5VA REAR PANEL

Rear View 10

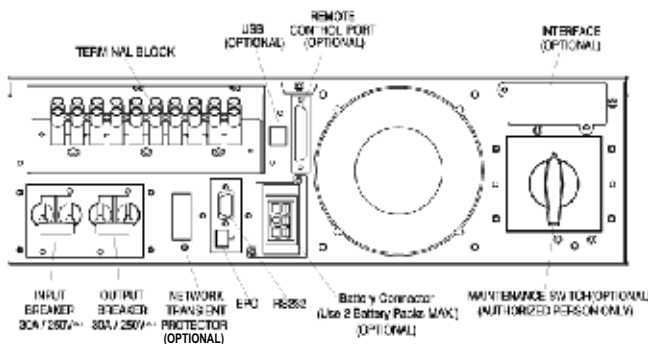

VRTE-6000-02 Rear View 11
 VRTE-8000-02 Rear View 11

6/8VA REAR PANEL

Rear View 11

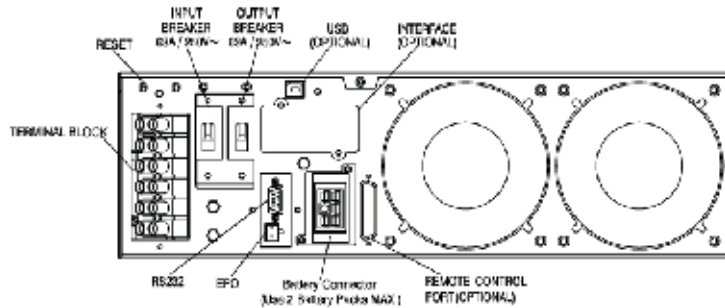

VRTE-10000-02 Rear View 12
 VRTE-12000-02 Rear View 12

10/12VA REAR PANEL

Rear View 12

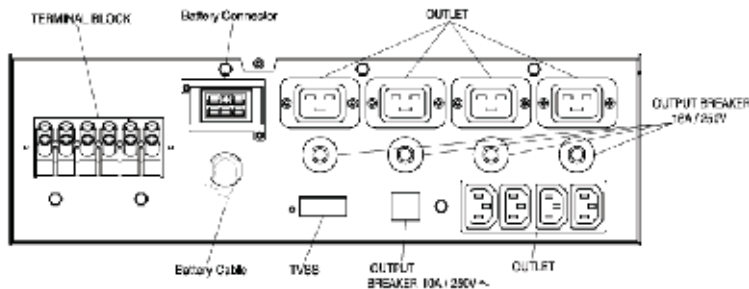

VRTE-10000-02 Rear View 12
 VRTE-12000-02 Rear View 12

Rack Mount Battery Pack

Rear View 13

5.4 Connecting an Extended Run-Time Battery Pack

Please refer to the Extended Run-Time Battery Pack user manual for detailed instructions.

5.5 Factory Default Settings

The following table shows the factory default settings for all UPS parameters as well as user selectable options. It is recommended that changes be made shortly after installation but prior to connection of the load/s.

Parameter	Options	Factory Default Setting
Output Voltage	208/220/230/240 VAC	230V
Input/Bypass Voltage Tolerance	±10% +10/-15% +15/-20%	+10/-15%
Input/Frequency Tolerance	±2% ±5% ±7%	±5%
High Efficiency Mode Setting	On/Off	Off
Free Run Mode	On/Off	On
Bypass In Free Run Mode	Disable/Enable	Disable
Alarm Silence	On/Off	Off
Site Wiring Fault	Enable/Disable	Disable
External Battery Pack Quantity	0, 1, 2	0

6. Communication Interface and Alarm Connections

6.1 Overview

All models are available with various interfaces which allow direct communication with, and control of, the computer. There is a choice of an RS-232 serial data interface, a USB data interface and an EPO (Emergency Power Off) connector. NOTE: The RS-232 port cannot be used when the USB interface is in use.

There is also an optional interface slot that allows for the installation of additional communications cards which can be used parallel with either the RS-232 or USB ports.

There are currently two cards available; an SNMP/WEB card which allows UPS management and power monitoring over a network or the internet and an AS/400 card which contains voltage-free relay contacts. Please contact tech support for more information on these options.

6.2 Connecting the UPS to a Computer

The communication cable that is supplied with the UPS is the ONLY one that should be used with it. Other cables may not work and may cause improper operation or the unit to malfunction.

Some options may come as a complete package containing a different cable, different power management software and additional hardware (i.e. interface card).

Please ensure that your operating system is supported by the provided software. Detailed software installation instructions are provided with or within the power management software.

6.3 RS-232 Interface Port (Standard)

The RS-232 interface uses a 9-pin female D-sub connector. This information consists of data regarding utility (AC) power, the load and the UPS. The interface port pins and their functions are identified in the following table:

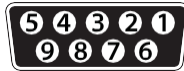

Pin#	Signal	Direction (UPS)	Functions
2	TxD	Output	TxD Output
3	RxD	Input	RxD / Inverter Off Input
5	Common		Common
6	CTS	Output	AC Failure Output
8	DCD	Output	Low Battery Output
9	RI	Output	+8 to +24 VDC Power

NOTE: Maximum rating is 12VDC

6.4 USB Port

Connecting the UPS to the computer is accomplished using a free USB port on the computer. A USB compliant operating system is necessary as well as hardware and the installation of a UPS driver. The serial port cannot be used when using the USB port. The required USB cable comes with the UPS when this option is specified. Connection is shown in Fig. 2.

6.5 EPO Port (Emergency Power Off)

The EPO port allows an immediate emergency shutdown to be activated remotely by disconnecting and removing power from the UPS output. Any manual or automatic shutdown procedures including those directed by power management software, are overridden. To activate, make sure the UPS and loads are first turned off. Remove the jumper from the EPO connector, and connect an insulated dry contact (NC, 60VDC, 30VAC, 20mA) using #17 AWG/1mm dia. wire to the EPO port. Power up the UPS and loads and test the EPO function.

6.6 Network Transient Protector (Optional)

The network transient protector, located on the rear panel, consists of both IN and OUT jacks housed on a separate RJ-45 (10BaseT) network card. If used, make sure that the input and the output are connected to the appropriate jack.

6.7 Load Segments (Where applicable)

The power management software controls individual sets of output receptacles on the UPS called "load segments" which provide controlled and sequential startup and shutdown of loads. Less critical equipment can be turned off during power outages saving battery power for more critical loads. Load segment status can be viewed from the LCD display on the UPS and can be changed if necessary. Load segments are usually controlled by the UPS management software.

7. Operational Instructions

7.1 Starting Up and Shutting Down the UPS

Start Up

1. Ensure that the unit has been correctly installed and that the input power cable is connected to a properly grounded AC outlet.
2. The unit is turned on by pushing the power push-button on the front panel for more than 3 seconds.
3. The unit sequences through its functional check, AC line synchronization and inverter startup. Power is then applied to the outlets.
4. During this sequence, the LCD panel displays "Ready On". An LED illuminates when output power is available and the LCD panel displays "Line mode".
5. The loads can now be turned on.

Shut Down

1. Shut down and turn off all connected loads.
2. Push the power push-button on the front panel for five seconds or more. An audible alarm will sound and the unit will shut down.
3. The LCD panel displays "UPS OFF" for a few seconds.
4. In emergency situations or applications which require such, the EPO located on the back of the unit should be used.

7.2 Push-button Operations

There are five operational push-buttons on the front panel:

1. **ON/OFF** - This push-button turns the unit on and off. To initiate a start-up or shut-down, press and hold this push-button for 3 seconds.
2. **STATUS** - This push-button is used to check current UPS and load settings, information and power measurements. To activate, press it for at least 2 seconds. There are 15 different functions that can be checked in this mode and pressing this push-button once each time scrolls through each function. If the push-button is not pressed within 10 seconds, the display reverts to its original mode.
3. **FUNC** - This push-button selects or enables various user-selectable parameters. There are 14 different parameters which can be scrolled through. To activate, press it for at least 2 secs. After locating a setting or particular parameter, press the Enter push-button to select that parameter and view its current setting. Press the Function push-button once again to scroll through the setting options. Once the desired setting is located, press the Enter push-button to enable the new setting and once again to save it (you will be prompted to do so). If no action is taken within 10 seconds, the display reverts to its previous mode.
4. **ENTER** - This push-button is used to enter, enable and/or confirm a selected function.
5. **ESCAPE** - This push-button is used to exit a menu and return to the main display.

7.3 Control Panel Indicators

Status, parameters and readings are displayed on the control panel via five LED indicators and/or an LCD screen and audible alarms compliment the display.

- ON**  This symbol is accompanied by a green LED that illuminates when the UPS has been turned on.

- ON-LINE**  This symbol is accompanied by a green LED that illuminates when the UPS is in normal or static bypass mode and AC voltage is present at the output terminals.

- ON-BAT**  This symbol is accompanied by a yellow LED that illuminates when the UPS is operating in battery mode.

- BYPASS**  This symbol is accompanied by a yellow LED that illuminates when the UPS is operating in bypass mode.

- FAULT**  This symbol is accompanied by a red LED that illuminates if an internal UPS error occurs. An audible alarm also sounds but can be muted by pressing any of the push-buttons on the front panel.

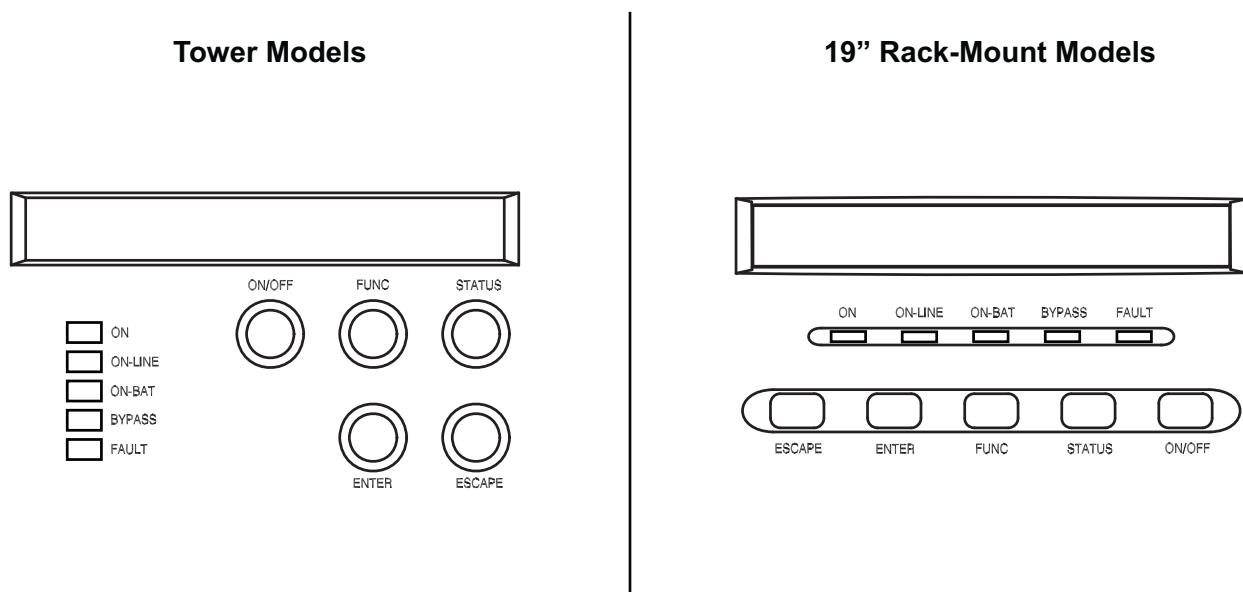

Fig. 5 Control panel

7.4 LCD Panel Display Modes

1. Normal Display Mode

UPS status is shown in this display mode. From this mode, the UPS data display mode and the setting display mode can be selected by pressing the appropriate push-button.

2. Data Display Mode

Various data and measurements are shown in this display mode. Pressing the Enter push-button (for 2 seconds to activate) scrolls through the following data:

Parameter	Indicates
O/P VOLT = xxx,x V	Output AC voltage
O/P FREQ = xx,x Hz	Output Frequency
I/P VOL T = xxx,x V	Input AC voltage
I/P FREQ = xx,x Hz	Input Frequency
BAT VOLT = xx,x V	Battery Voltage
O/P LOAD% = xx %	Load expressed as a percentage of the maximum load
O/P W = x W	Output Watts
O/P VA = x VA	Output VA
O/P CURR = x A	Output Current
BACKUP TIME = xx min	Estimated Backup time in minutes
BAT CHARG = xx %	Approximate Battery capacity expressed as a percentage
TEMPERATURE = xx °C	Approximate ambient temperature
BAT PACK NUM = x	External Battery Pack quantity
RATING = xxxx VA U	UPS Rating
CPU VERSION = xx.x	CPU Version

3. Configuration/Setting Display Mode

1. The current UPS configuration/settings are shown in this mode.
2. To enter this, press the Function/Scroll push-button for two seconds. The first configuration parameter will be shown on the LCD display.
3. Press the Function/Scroll push-button to scroll through each parameter.
4. Press the Enter push-button to select the parameter.
5. Press the Function/Scroll push-button to scroll through the options for the selected parameter.
6. Press the Enter push-button to select the option. You will be prompted to save the selection, so press the Enter push-button to confirm and save your selection. See the table below for further details.
7. If no action is taken within 10 seconds, the display reverts to normal display mode.

Settings	LCD Display	Detail	Selection/Option Default	
Output Voltage	O/P V Setting	Nominal Voltage Selection	208/220/230/240V	230V
Input / Frequency	I/P F Setting	Input frequency range selection when UPS is in free run mode	±2% ±5% ±7%	±5%
Input / Bypass Voltage	I/P Bypass Set	Input Voltage range selection when bypass is available	±10% +10/-15% +15/-20%	+10/-15%
Free Run Mode • Bypass Enable / Disable in Free run Mode	Free Run Set	UPS run in Free run mode selection (unsynchronized)	ON / OFF	ON
	Bypass disable	Allows the UPS to go into bypass mode when unsynchronized	Disable / Enable	Disable
High Efficiency Mode	HE Mode Set	Allows the UPS to run in high efficiency mode	ON / OFF	OFF
Manual Bypass Force	Manual Bypass	Forces the UPS into bypass mode. (For service only)	ON / OFF	OFF
Load Segment / Group Management	Outlet Setting	Allows load group/segments to be turned on and off from the front panel	1 ON & 2 ON 1 OFF & 2 ON 1 OFF & 2 OFF 1 ON & 2 OFF	ON & ON
Initiate Battery Test	Battery Test	Detects whether battery is in good condition or not.		
Alarm Silence	Silence Set	Enables or disables alarm silencing	ON/OFF	OFF
External Battery Pack Quantity	Bat Cabinet Set	Allows the UPS to more accurately determine remaining backup time	1 2 3 4 5	1
Site Wiring Fault Alarm	Sit Fault Set	Enables or disables site wiring fault alarm	Enable /Disable	Disable
Language	Language	Selects load language	English, German, French, Spanish, Italian	English
Generator Mode • Bypass Enable / Disable in Free run Mode	Generator	Places UPS in generator mode ***	ON / OFF	OFF
	Bypass disable	Allows the UPS to go into bypass mode when unsynchronized	Disable / Enable	Disable
RS-232 communication	RS232 Control	Enables or disables RS-232 communication capability	Enable / Disable	ENABLE

7.5 Manual UPS or Battery Test

A manual UPS or battery test can be initiated from the UPS configuration/settings display and can be carried out even when the UPS is not charging the battery. To initiate, scroll through the parameters until Manual Bat test is displayed on the LCD panel. Press the Enter push-button twice.

** NOTE: In order for the UPS and power management software to function correctly, Manual Bypass should always be set to OFF as the load will not be protected by the UPS when Manual Bypass is ON.

*** NOTE: The UPS should be turned off but kept connected to the AC power supply before activating the Generator Mode.

7.6 Sense Mode - Normal and Generator Waveforms

This is used to broaden the input parameters to accommodate the voltage fluctuations created by a backup generator or a noisy line. The factory default setting is normal, where the unit runs on normal parameters. Switching to Generator makes it run on noisy generator parameters. If the unit constantly switches between line and battery modes due to a noisy line, select generator mode to prevent unnecessary transfers I returns. In generator mode, the acceptable range of input frequency and voltage is expanded to accommodate the voltage and frequency fluctuations created by a generator or a power source of such kind. Use a generator with electronic speed and voltage controls which typically produces Total Harmonic Distortion in % (THD) of less than 10%. Generators with mechanical governors can force the system to run continuously in Battery mode.

Before installation, compare the generator's output voltage to the UPS's input voltage requirements as listed on both nameplates. To insure the system's smooth operation, use a generator capable of supplying 2X or twice as much power as required by the total load.

7.7 Audible Alarms

1. If the UPS is on battery and the "ON BATTERY" LED is illuminated, the unit will beep every 5 seconds.
2. If the battery capacity is low and the "ON BATTERY" LED is flashing, the unit will beep twice every 5 seconds.
3. If the UPS is in bypass mode and the "BYPASS" LED is illuminated, the unit will not beep.
4. If the UPS has an internal fault and the "ALARM" LED is illuminated, the unit will emit a constant alarm tone and display the cause of the fault on the LCD panel.
5. To silence an alarm, press any of the three push-buttons on the front panel. The alarm will be silenced under all conditions except when the battery is low, under which condition the alarm cannot be silenced.
6. The audible alarm function can be de-activated internally by selecting the appropriate parameter from the LCD panel.

7.8 Troubleshooting

LCD	Alarms	Problem Description	Corrective Action
Output Overload	Two beeps per second	The UPS is overloaded (in Line Mode). The power rating of the connected equipment exceeds the capacity (VA rating) of the UPS. The UPS operates in bypass mode.	Reduce the load on the UPS by disconnecting less critical equipment. Once the total load is below the maximum specified by the UPS, it will switch from bypass back to normal mode.
Battery Test	No audible tone	The UPS is performing a battery test.	No action required. The UPS will resume normal operation once the battery test has been successfully completed.
Over-Charge	Constant audible tone	The batteries have been over-charged.	Turn off protected loads, then turn off the UPS and contact tech support.
Low Battery	Two beeps every 5 seconds	The unit is operating on battery power but will shut down shortly due to low battery voltage.	Initiate a controlled shutdown of connected equipment immediately. The UPS will restart automatically once AC power has been restored.
On-Battery	One beep every 5 seconds	The unit is operating on battery power.	No action required. A controlled shutdown of connected equipment can be initiated if necessary.
Charger Failure	Constant audible tone	Battery charger failure.	Turn off protected loads, then turn off the UPS and contact tech support.
Over-Temperature	Constant audible tone	High ambient temperature.	Check that the UPS cooling fans and ventilation holes are not blocked. Check that the ambient temperature surrounding the UPS is not above 104°F (40°C). If these conditions do not exist but the problem persists, contact tech support.
Output Short Circuit	Constant audible tone	Output short circuit.	Turn off protected loads, then turn off UPS and contact tech support.
High Output Voltage	Constant audible tone	Output voltage too high.	Turn off protected loads, then turn off UPS and contact tech support.
Low Output Voltage	Constant audible tone	Output voltage too low.	Turn off protected loads, then turn off UPS and contact tech support.
Bus Fault	Two beeps per second	Internal DC bus voltage too high.	Turn off protected loads, then turn off UPS and contact tech support.
Site Wiring Fault	One beep per second	Incorrect AC power connection polarity. Ground connection missing or faulty.	Have the wiring fault corrected or alternately, disable the related alarm on the UPS
Line Abnormal	One beep per second	Incorrect AC Line backed up during auto restart.	Connect correct AC power line.

FOR ADDITIONAL ASSISTANCE, PLEASE CONTACT US AT 310-689-2328 OR SUPPORT@MARATHON-POWER.COM

8. Maintenance

As long as all the installation, environmental and operational requirements have been followed and met, the UPS will require little or no maintenance for many years. The batteries are the only component that should eventually need replacing. Their useful life depends primarily on the following two factors; the ambient temperature of the environment in which the UPS is located and the number of times they're called into use (i.e. discharged). In both cases, the lower the number, the longer they will last. At an ambient temperature of 77°F (25°C), typical battery lifetime is 3-5 years. A test of the UPS and batteries should be carried out at regular intervals (every 6 to 12 months) to verify that back-up time is still adequate for the application. The UPS should also be charged every six months if it is kept in storage and not used.

8.1 Battery Replacement

1. For Tower Models: The batteries are all located on one side or both sides of the UPS behind a removable panel.
2. For Rackmount Models: Batteries are in a separate enclosure.
3. The UPS must be turned off completely and the loads disconnected.

Battery Type: LEAD - ACID TYPE

Battery Rating: 240 VDC, 7Ah - 9.0 Ah max.

Battery Numbers: Tower 20 or 40, Rackmount 20 PCS

The following procedure applies to all models:



WARNING! Batteries may cause electrical shock or burn from high short circuit currents. Please observe the following precautions when working with them:

1. Remove jewelry and metal objects such as watches and rings.
2. Use tools that have insulated handles.
3. Prevent tools and other metal objects from coming into contact with the batteries.
4. Batteries can pose an electric energy hazard. Do not rewire, modify, or change any battery wiring or connections. Such modifications can cause serious injury and/or damage.
5. Replace with the same type, rating and quantity as the original batteries.
6. Do NOT disconnect the batteries while the UPS is in Battery mode.
7. Remove battery grounds during installation and maintenance to reduce likelihood of shock. Remove the connection from ground if any part of the battery is determined to be grounded.
8. Risk of Electric Shock – Battery Circuit is not isolated from ac input; hazardous voltage may exist between battery terminals and ground. Test before touching.

1. The panels of the UPS can be removed by unfastening all the appropriate screws and detaching them.
CAUTION: Keep tools and hands away from the DC bus - dangerously high voltage is present!
2. Once the covers have been removed and placed out of the way, disconnect the positive (+) RED and negative (-) BLACK bus wires from the battery string, then the interconnecting cable between each battery.
3. Then remove the metal battery covers/plates/brackets and set them aside in a safe place.
4. Slowly slide each battery out from the UPS.
5. Take note of each battery's physical orientation, polarity and mechanical connections.
6. Replace the batteries and reconnect them according to the details noted in step 5.
7. Carefully replace the metal battery covers/plates/brackets making sure to avoid a short circuit with a battery or the DC bus.
8. Reinstall the panels.

Step 1: Disassemble top cover screws, then remove the top cover.

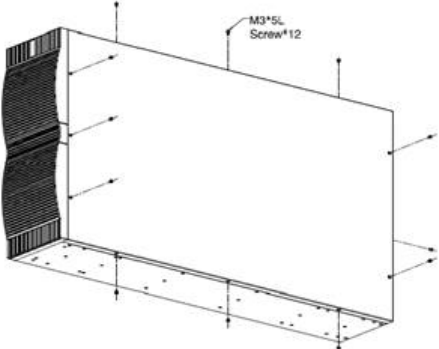

Step 2: Disassemble screws on battery tray bracket, after removing the battery tray bracket.

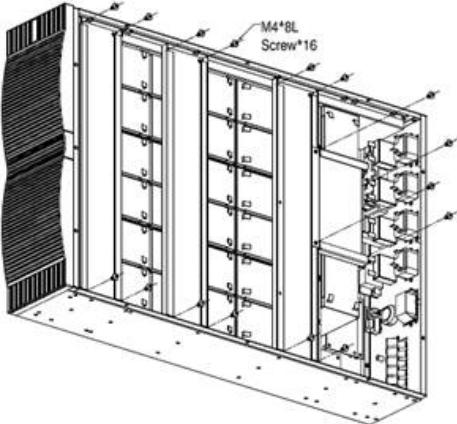

Step 3: See the configuration diagram.

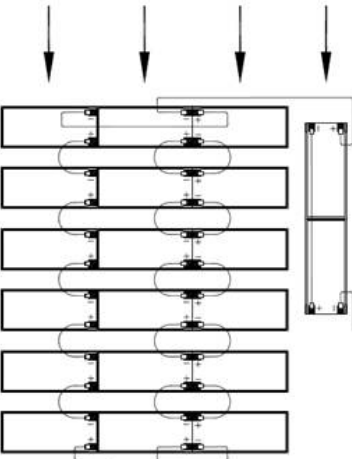

9. Specifications

GENERAL

Rated power: 4kVA, 5kVA, 6kVA, 8kVA, 10kVA, 12kVA with a power factor of 0.7
Technology: True on-line, double conversion topology with integral automatic bypass

INPUT

Phase: Single phase plus ground
Input Bypass Voltage: 184 - 265 VAC (+15% to -20% of 230V nominal - user selectable)
Input Voltage range: 120 / 140 / 160 / 180VAC - 276 VAC
(120V - 276V @ 25% load, 140V - 276V @ 50% load, 160V - 276V @ 75% load, 180V - 276V @ 100% load)
Frequency: 50 / 60 Hz Auto-sensing
AC Frequency range: 45 - 65 Hz
Synchronization range: $\pm 3\text{H}$
Input Current: 4kVA - 15A, 5kVA - 19A, 6kVA - 23A, 8kVA - 30A, 10kVA - 38A, 12kVA - 46A
Input Power factor: 0.97

OUTPUT

Output Voltage: 208 / 220 / 230 / 240 VAC (user selectable)
Voltage regulation: $\pm 2\%$
Voltage distortion: $< 5\%$ THD with non-linear loads, $< 3\%$ THD with linear loads
Frequency regulation: ± 0.25 Hz (while on battery or in free run mode)
Dynamic response: $\pm 9\%$ max from 100% to 20% or from 20% to 100% linear
load Overload capacity: 100 - 125% for 1 min, 126 - 150% for 10 sec
Efficiency (HE Mode): Greater than
95% Efficiency (On-line Mode): Greater than 88%
Crest Factor: 3 : 1

ENVIRONMENTAL

Ambient temperature range: +32 °F to +104°F (+0 °C to +40 °C)
Optimum temperature range: +59 °F to +77°F (+15 °C to +25 °C)
Storage temperature: +5 °F to +122°F (-15 °C to +50 °C)
Cooling: Forced air cooling
Humidity: 0-95%, non-condensing
Elevation: 10,000 feet max (operation), 45,000 feet (storage)
Audible noise: < 55 db normal and battery mode (4000-8000 VA models)
 < 55 db normal and battery mode (10000-12000 VA models)

STANDARDS

Safety: EN50091-1-1
Emissions: EN50091-2 class B
Immunity: EN50091-2
Conformity: UL 1778, CSA 107.1, 107.2, CE (Model Dependent)
Transient Immunity: Per IEEE C 61000 4-5 level 3

Tower Models without Output Isolation (ISO) Transformer

Model Number	VTWE-4000-02	VTWE-5000-02	VTWE-6000-02	VTWE-8000-02	VTWE-10000-02	VTWE-12000-02
Capacity	4kVA / 2.8kW	5kVA / 3.5kW	6kVA / 4.2kW	8kVA / 5.6kW	10kVA / 7kW	12kVA / 8.4kW
Input Connection	Hardwire Terminal Block or Fixed Input Power Cord		Hardwire Terminal Block			
Output Connection Options	IEC 320 10A and 16A IEC and NEMA L6-30R IEC and Shuko (European)		Hardwire Terminal Block and/or various IEC Receptacles (optional) Hardwire Terminal Block and/or various NEMA Receptacles (optional)			
Battery Type & Rating	Sealed, lead-acid 7.2Ah/12V	Sealed, lead-acid 9Ah/12V	Sealed, lead-acid 7.2Ah/12V	Sealed, lead-acid 7.2Ah/12V	Sealed, lead-acid 9Ah/12V	Sealed, lead-acid 7.2Ah/12V
Battery Quantity	10	10	20	20	20	40
Backup Time (full load)	6 min	6 min	7 min	5 min	6 min	5 min
Recharge Time	<4 hours to 90 %					
Dimensions in / mm W x D x H	10.1 x 21.1 x 17.3 257 x 537 x 440		10.2 x 23.2 x 22.4 257 x 590x 570	10.1x 27.2 x 28.2 257 x 690 x 715		13.5 x 27 x 35.6 342 x 687 x 905
Weight lbs. / kg	95 / 43		190/ 86	247 / 112		419 / 190

Tower Models with Output Isolation (ISO) Transformer

Model Number	VTWE-6000-21	VTWE-8000-21	VTWE-10000-21	VTWE-12000-21
Capacity	6kVA 4.2kW	8kVA 5.6kW	10kVA 7kW	12kVA 8.4kW
Input Connection	Hardwire Terminal Block or Fixed Input Power Cord		Hardwire Terminal Block	
Output Connection Options	Hardwire Terminal Block (standard) and/or various IEC Receptacles (optional) Hardwire Terminal Block (standard) and/or various NEMA Receptacles (optional)			
Battery Type & Rating	Sealed, lead-acid 7.2Ah/12V	Sealed, lead-acid 7.2Ah/12V	Sealed, lead-acid 9Ah/12V	Sealed, lead-acid 7.2Ah/12V
Battery Quantity	20	20	20	20 x 2SET
Backup Time (full load)	6 min	6 min	7 min	5 min
Recharge Time	<4 hours to 90 %			
Dimensions in / mm W x D x H	10.1 x 23.2 x 27.6 257 x 590 x 700	13.4 x 27.2 x 28.1 342 x 690 x 715	13.4 x 27.2 x 28.1 342 x 690 x 715	13.5 x 34.0 x 35.6 342 x 863 x 905
Weight lbs. / kg	270.6 / 123	286 / 130	286 / 130	396 / 180

19" Rack Mount Models

Model Number	VRTE-4000-02	VRTE-5000-02	VRTE-6000-02	VRTE-8000-02	VRTE-10000-02
Capacity	4kVA / 2.8kW	5kVA / 3.5kW	6kVA / 4.2kW	8kVA / 5.6kW	10kVA / 7kW
Input Connection	Hardwire Terminal Block				
Output Connection Options	Hardwire Terminal Block (standard) and/or various IEC Receptacles (optional) Hardwire Terminal Block (standard) and/or various NEMA Receptacles (optional)				
Battery Type & Rating	Sealed, lead-acid 5Ah/12V	Sealed, lead-acid 5Ah/12V	No Internal Batteries External Battery Pack (EBP) Required		
Battery Quantity	10*	10*			
Backup Time (full load)	4 min	3 min			
Recharge Time	<4 hours to 90 %				
Dimensions in / mm W x D x H	16.9 x 25.9 x 5.1 428 x 657 x 130		UPS ONLY 16.9 x 23.6 x 5.1 428 x 597 x 130	UPS ONLY 16.9 x 25.9 x 5.1 428 x 657 x 130	
Weight lbs. / kg	88 / 40		UPS ONLY 44.1 / 20	UPS ONLY 53.6 / 24.3	

Tower External Battery Packs

Model Number	VBPT-0007-120	VBPT-0007-120	VBPT-0007-240	VBPT-0009-240	VBPT-0009-240	VBPT-0009-240
Capacity	4000VA	5000VA	6000VA	8000VA	10000VA	12000VA
AC Connections	IEC Inlet at 240VAC					
DC Connections	Panel mounted, color-coded Anderson connector					
Battery Type & Rating	Sealed, lead-acid 7.2Ah/12V					Sealed, lead-acid 9Ah/12V
Battery Quantity	20			40		
Backup Time (full load)	See run-time table					
Recharge Time	<8 hours to 90 %					
Dimensions in / mm W x D x H	10.2 x 21.1 x 17.3 258 x 537 x 440		10.2 x 23.2 x 22.4 258 x 590 x 570	10.2 x 23.1 x 22.4 258 x 587 x 570		
Weight lbs. / kg	154.3 / 70		194 / 88	322 / 148		

19" Rack Mount External Battery Packs (3U)

Model Number	VBPR-0007-120	VBPR-0007-120	VBPR-0007-240	VBPR-0009-240	VBPR-0009-240
Capacity	4000VA	5000VA	6000VA	8000VA	10000VA
Input Connection	Fixed cord with color- coded Anderson connector				
Output Connection	Panel mounted, color-coded Anderson connector				
Battery Type & Rating	Sealed, lead-acid 7.2Ah/12V			Sealed, lead-acid 9Ah/12V	
Battery Quantity	20				
Backup Time (full load)	See run-time table				
Recharge Time	<8 hours to 90 %				
Dimensions in / mm W x D x H	16.9 x 25.9 x 15.1 428 x 657 x 130		16.9 x 23.5 x 15.1 428 x 571 x 130	16.9 x 25.9 x 15.1 428 x 657 x 130	
Weight lbs. / kg	150 / 68		145.5 / 66	150 / 68	

*4kVA and 5kVA models have internal batteries.

**6kVA, 8kVA, 10kVA and 12kVA models have external batteries.

UPS Shutdown Procedure (10kVA)

Step 1:

Press and hold the ON/OFF button on the front panel for 2 seconds until a long beep is heard and "Shutdown" shows up on the screen,
The display will indicate "UPS OFF", this will appear for a brief moment and disappear.

Step 2:

After the text disappears and just the back-light is On, turn OFF the input breaker.

Step 3:

Next, turn OFF the battery breaker and wait until all the fans stop and come to a complete halt. This will complete the shutdown procedure.

10. Warranty

10.1 Limited Three-Year Warranty and Exclusions

NOTE: For this warranty to be valid, completed registration information must be received within 30 days of original purchase.

Marathon Power warrants to the original purchaser, who must have properly registered the product within 30 days of purchase, and not for the benefit of anyone else that this product at the time of its sale by Marathon Power is free of defects in materials and workmanship for three (3) years (batteries for 2 years within the USA, Canada and Mexico, otherwise 1 year) from the original purchase date. Marathon Power will correct such defects by repair or replacement, at its option, if within such three year period the product is returned prepaid and all warranty claim instructions are followed. This warranty excludes labor for removal or reinstallation of this product. This warranty is void if this product is installed improperly or in an improper environment, overloaded, misused, opened, abused, or altered in any manner, or is not used under normal operating conditions or not in accordance with all labels or instructions. There are no other or implied warranties of any kind, including merchantability and fitness for a particular purpose, but if any implied warranty is required by the applicable jurisdiction, the duration of any such implied warranty, including merchantability and fitness for a particular purpose, is limited to three years. Marathon Power is not liable for incidental, indirect, special or consequential damages, including damage to, or loss of use of, any equipment, lost sales or profits or delay or failure to perform this warranty obligation.

10.2 Limitations & Claims

This warranty does not cover any Marathon Power UPS or any properly connected electronic equipment which has been improperly installed, overloaded, abused or altered in any manner, or is not used under normal operating conditions, or in accordance with any labels or instructions, and does not cover any damage to properly connected electronic equipment resulting from a cause other than a "surge".

Damage caused by failure to provide a suitable installation environment for the product (including, but not limited to, lack of a good ground) will not be covered by this warranty. This warranty does not apply to damage caused by direct lightning strikes, or damage caused by electrical disturbances that exceed published product specifications. These products are intended to limit the maximum amplitude of transient voltage surges on power lines to specified values. They are not intended to function as surge arrestors. The UPS is intended to be installed on the load side of the service entrance and has been tested to verify that transient voltage surges are limited when subject to non-repetitive transient voltage surge events. This warranty excludes any incidental, indirect, special or consequential damages, including without limitation, labor for removal or reinstallation of the Marathon Power UPS or any connected electronic equipment, data loss or alteration loss of equipment use, lost sales or profits and any such damages for delay or failure to perform this warranty obligation. This warranty is in lieu of and excludes all implied warranties of merchantability or fitness for use. In addition, the warranty does not cover restoration of lost data and reinstallation of software. Some states may not allow the exclusion or limitation of incidental or consequential damages or other remedies, so the above exclusions or limitations may not apply to you.

Take the following steps to file a warranty claim: Contact us at Marathon Power, Inc., Attn: Returns, 2538 E. 54th Street, Huntington Park, California 90255 or call (310) 689-2328 within 30 days of the occurrence. Be prepared to provide detailed information about the event, any damage, the UPS model number, purchase date and location. You will then be provided with a Return Authorization Number (RAN), and be instructed to forward your proof of purchase (receipt), an explanation of the event and your UPS. If Marathon Power determines that the damage was due to a "surge", we may request that all connected equipment be submitted for evaluation. Marathon Power is not responsible for shipping costs. In the event that the equipment has been damaged by a "surge" Marathon Power will reimburse you for repair or replacement at fair market value (on a pro rata basis) as indicated by the respective amounts above. The warranty coverage is above and beyond, only to the extent needed, of that provided by any other source, including but not limited to any connected equipment coverage, any manufacturer's warranty or insurance policy. To receive payment for repair to damage due to a "surge," the original purchaser should (upon prior approval from Marathon Power) have such equipment repaired by an authorized service center of such equipment's manufacturer. The original purchaser will submit a repair bill along with a statement from the repair facility documenting the nature of the damage and how it was sustained to said equipment.



Marathon Power Inc., 2023

2538 E. 54th Street
Huntington Park, CA
Office: 310-689-2328
Fax: 310-689-2329
support@marathon-power.com
www.marathon-power.com