



Vault Series

**True On Line,
Double Conversion
Uninterruptible Power Supply**

**USER MANUAL
FOR MODELS:
700VA - 3000VA**

Table of Contents

Section	Page
1.Introduction	7
2.System Description	7
2.1 General Description	7
2.2 System Configuration	7
3.Safety Information	9
4.Storage	9
5.Installation	10
5.1 System Configuration and Sizing	10
5.2 Environment	12
5.2.a Tower Models - 700 / 1K / 1.5KVA Rear Panel View	12
5.2.b Tower Models - 2K / 3KVA Rear Panel View	13
5.2.c 19" Rack-Mount Models (1U) - 700 / 1KVA Rear Panel View	14
5.2.d 19" Rack-Tower Models (2U) - 700 / 1K / 1.5KVA Rear Panel View	15
5.2.e 19" Rack-Tower Models (2U) - 2K / 3KVA Rear Panel View	16
5.3 AC Power and Load Connection	17
5.4 Connecting an Extended Run-Time battery Pack	18
5.5 Factory Default Settings	18
6.Communication Interface and Alarm Connections	18
6.1 Overview	18
6.2 Connecting the UPS to a Computer.....	18
6.3 RS-232 Interface Port	19
6.4 USB Port	19
6.5 EPO (Emergency Power Off) Port	19
6.6 Network Transient Protector	19
6.7 Load Segments	19
7.Operational Instructions	20
7.1 Starting Up and Shutting Down the UPS.....	20
7.2 Push-button Operations	20
7.3 Control Panel Indicators	21
7.4 LCD Panel Display Modes	22
7.5 Manual UPS or Battery Test	23
7.6 Audible Alarms	24
7.7 Troubleshooting	25
8.Maintenance	26
8.1 Battery Replacement	26
8.2 Storage Requirements	27
8.3 Maintenance and Precautions.....	28
9.Specifications	29
10.Warranties	33

EMC Statements

FCC Part 15

NOTICE: Pursuant to section 15 of the FCC rules, this product has been tested and thereby complies with the conditions of a Class B (700-2000VA) and Class A (3000VA) digital device, which have been established for offering sufficient protection against dangerous interference for installation in a residential area. Installation and use of the equipment should comply with the instructions provided in order to avoid such interference due to the amount of radio frequency energy that is radiated and generated by the equipment. In spite of this, we cannot assure that a certain amount of interference may not occur in some installations. If, by turning on and off, it can be deduced that your radio or television reception is found to be influenced by harmful interference from the equipment, it is recommended that one of the following preventive measures be used:

1. Place the receiving antenna in a separate location or orientation.
2. Ensure a greater distance is achieved between the receiver and the equipment.
3. Ensure that your equipment is connected to an outlet on a separate circuit than the receiver.
4. Contact a technician experienced with radio and TV or call tech support for further assistance.

ICES-003

This Class B Interference Causing Equipment meets all requirements of the Canadian Interference Causing Equipment Regulations ICES-003. Cet appareil numérique de la classe B respecte toutes les exigences du Règlement sur le matériel brouilleur du Canada.

Declaration of Conformity Request

Units labeled with a CE mark comply with the following standards and directives:

1. Harmonic Standards: EN 50091-1-1, EN62040-1-1 and EN 50091-2, EN62040-2
2. EU Directives: 73/23/EEC, Council Directive on equipment designed for use within certain voltage limits.

93/68/EEC, Amending Directive 73/23/EEC

89/336/EEC, Council Directive relating to electromagnetic compatibility

92/31/EEC, Amending Directive 89/336/EEC relating to EMC

The EC Declaration of Conformity is available upon request for products with a CE mark.



IMPORTANT SAFETY INSTRUCTIONS SAVE THESE INSTRUCTIONS



1. This Manual Contains Important Instructions that should be followed during Installation and Maintenance of the UPS and Batteries.
2. The equipment can be operated by any individual. No previous experience is required.
3. **CAUTION (UPS with Internal Batteries):** Risk of electric shock - Hazardous live parts inside this unit are energized from the battery supply even when the input AC power is disconnected.
4. **CAUTION (No User Serviceable Parts):** Risk of electric shock, do not remove cover. No user serviceable parts inside. Refer servicing to qualified service personnel.
5. **CAUTION (Non-isolated Battery Supply):** Risk of electric shock, battery circuit is not isolated from AC input / output; hazardous voltage may exist between battery terminals and ground. Test before touching.
6. **WARNING (Fuses):** To reduce the risk of fire, replace only with the same type and rating of fuse.
7. **WARNING:** Intended for installation in a controlled environment. The maximum ambient temperature is 40°C.
8. **CAUTION:** When replacing batteries, replace with the same type and number of batteries: Only use sealed lead acid battery, rated 12 V, 8.5 Ah max.
9. **CAUTION:** Do not dispose of batteries in a fire, as they may explode.
10. **CAUTION:** Do not open or damage the battery, electrolyte may be released which is harmful to the skin and eyes.
11. **CAUTION:** A battery can present a risk of electric shock and high short circuit current. The following precautions should be taken when working with batteries:
 - a. Remove watches, rings and other jewelry or metal objects.
 - b. Use only tools with insulated handles.
 - c. Wear rubber gloves and boots.
 - d. Do not lay tools or metal parts on top of batteries.
 - e. Disconnect charging source prior to connecting or disconnecting battery terminals.
12. To reduce the risk of electric shock, disconnect the UPS from the AC input power supply before installing a communication interface cable. Reconnect the power cord only after communication interconnections have been made.
13. Battery replacement should be performed or supervised by personnel with knowledge of batteries. Keep unauthorized personnel away from the batteries.
14. **CAUTION:** To reduce risk of fire, use only No. 26 AWG or larger telecommunication line cord.
15. **CAUTION:** To reduce risk of fire, connect only to a circuit provided with 25 amperes maximum branch circuit over-current protection in accordance with the National Electric Code, ANSI/NFPA 70". An AC output disconnect shall be provided by others.

The instructions contained within this safety manual are extremely important and should be closely followed at all times during installation and follow-up maintenance of the UPS and battery.



CAUTION

The unit contains dangerous voltage levels. If the UPS is on, but not connected to an AC power supply, the unit's outlets may still be energized with voltage due to the presence of an internal power source, i.e. the battery.

The unit should be installed indoors in an area free of electrically-conductive contaminants.

The unit should be installed in a temperature and humidity controlled environment in order to reduce the risk of electric shock.

Only the power cord that is supplied with the unit should be used to connect it to the AC power supply. The equipment should also be located as close as possible to the AC supply.

Servicing and maintenance should only be carried out by qualified service personnel with the exception of battery replacement.

Before carrying out battery or fuse replacement or shipping the unit, first ensure that the unit is turned off completely and all cables are disconnected.

For additional safety instructions, please use the Safety Manual as reference.

Symbols

The following symbols warn of precautions and provide directions or instruction regarding the unit:



RISK OF ELECTRIC SHOCK – Indicates that there is a risk of electric shock.



CAUTION: REFER TO OPERATOR'S MANUAL – Indicates that the operator's manual should be referred to for additional information, such as operating and maintenance instructions.



SAFE GROUNDING TERMINAL - Indicates primary safe ground.



LOAD ON/OFF – Indicates that the associated push-button turns the unit and its output receptacles on or off.



RJ-45 CONNECTOR – Indicates that this connector provides network interface connections and that telephone or telecommunications equipment should NOT be plugged into it.



DISPOSAL – Indicates that the UPS and its batteries should be disposed of in the correct manner since the batteries are of the lead-acid type. It is recommended that the batteries be recycled.

1. Introduction

The information provided in this manual refers to our single phase, 700VA through 3000VA, true on-line uninterruptible power supplies. It covers basic functions, operating and installation instructions, cautionary notes and detail on how to ship, store and handle them. Installation must be carried out in accordance with this manual as well as local electrical regulations and should only be performed by qualified personnel to avoid the risk of electric shock or damage to the unit. Any warranties covering these units will become void if the unit is found to have been incorrectly connected or tampered with.

2. System Description

2.1 General description

Configured as a true, on-line double conversion unit, this UPS is able to supply seamless, pure single-phase AC power to critical loads while keeping the batteries charged continuously. In the event that a power interruption lasts longer than the UPS's backup time capability, it will shut down to avoid complete battery discharge. As soon as AC power is restored, the UPS will automatically restart and begin recharging the batteries.

A block diagram of the UPS infrastructure is shown in Fig. 1:

- An input filter reduces transients, noise and surges on the incoming AC supply
- AC power is rectified and regulated by the rectifier supplying power to the inverter and battery converter. Battery voltage and charge is maintained at optimum levels.
- DC power is converted to AC power by the inverter which passes it on to the load.
- Power is supplied from the battery during a power failure or deep voltage sag.
- The converter increases voltage to an appropriate level for the inverter.
- An integral automatic bypass switch seamlessly circumvents the electronics in the event of a component failure ensuring continuous power to the load.

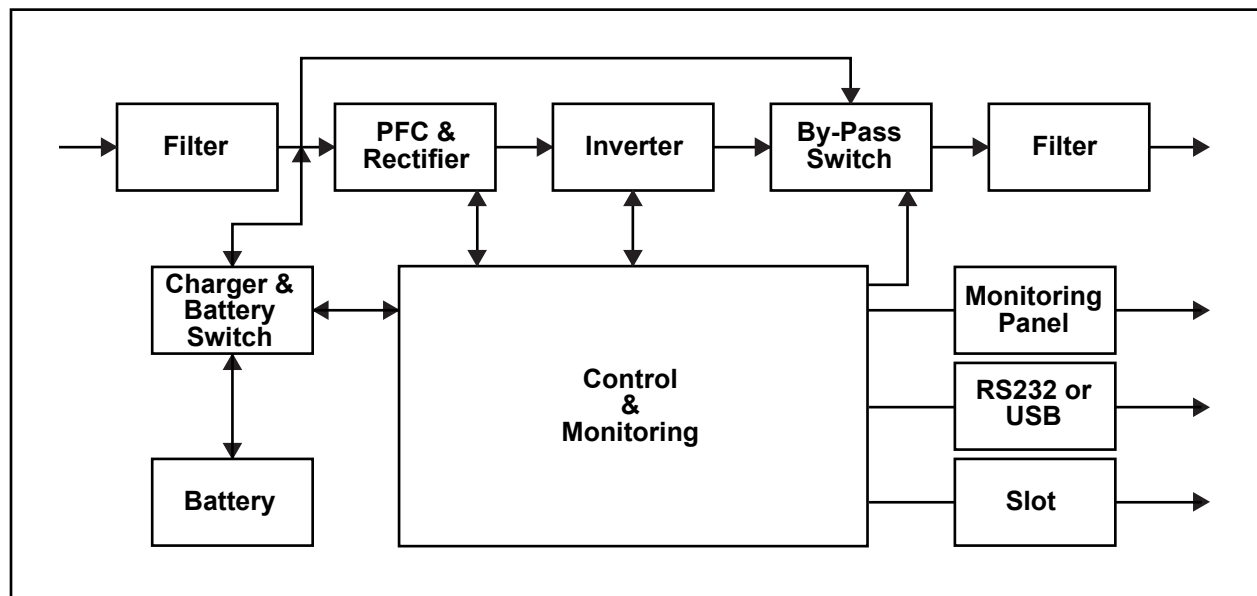

Efficiency Optimizer

The Efficiency Optimizer is a unique feature that reduces long-term cost of ownership by minimizing power loss and reducing power consumption thereby making the entire system extremely efficient. Simply put, the UPS automatically alternates between bypass and on-line modes depending upon the condition of the incoming AC power. The UPS will remain in on-line mode during any type of power disturbance but unlike traditional on-line systems, will switch to bypass mode when AC power is within acceptable limits in order to achieve greatest efficiency. Power disturbances can be detected in less than a second, and on-line mode reactivated immediately. Switching back to online mode occurs when the input voltage is outside of $\pm 10\%$ of nominal ($\pm 15\%$ selectable), when input frequency is outside of $\pm 3\text{Hz}$ or when no AC power is present.

While the default operation is on-line mode, bypass can be activated via the LCD panel. The Efficiency Optimizer can be de-activated and the unit can be run permanently in on-line mode if preferred.

Free Run Mode

Free run mode is defined as being when the output frequency is fixed and not synchronized with the input frequency. When activated, the output frequency regulation is automatically set to either 50 or 60 Hz and is regulated to within $\pm 0.25\text{Hz}$. Please refer to Chapter 7 for instructions on how to activate bypass mode while the UPS is in free run mode.

Sense Mode - Normal and Generator Waveforms

This is used to broaden the input parameters to accommodate the voltage fluctuations created by a backup generator or a noisy line. The factory default setting is normal, where the unit runs on normal parameters. Switching to Generator makes it run on noisy generator parameters. If the unit constantly switches between line and battery modes due to a noisy line, select generator mode to prevent unnecessary transfers / returns.

In generator mode, the acceptable range of input frequency and voltage is expanded to accommodate the voltage and frequency fluctuations created by a generator or a power source of such kind. Use a generator with electronic speed and voltage controls which typically produces Total Harmonic Distortion in % (THD) of less than 10%. Generators with mechanical governors can force the system to run continuously in Battery mode.

Before installation, compare the generator's output voltage to the UPS's input voltage requirements as listed on both nameplates. To insure the system's smooth operation, use a generator capable of supplying 2X or twice as much power as required by the total load.

Diagnostic tests

Whenever the UPS is turned on, a diagnostic test to check the status of the internal electronics and battery is activated. Any errors or faults are displayed on the LCD panel.

An advanced battery management system continuously monitors the condition of the batteries and notifies the user in advance if replacement is needed.

In addition, a battery discharge test is performed every 30 days in normal mode operation, and any problems are displayed on the LCD panel.

Diagnostic tests can be performed manually from the LCD panel at any time, except during the first 24 hours after startup while the UPS is in charging mode (see Chapter 7).

3. Safety Information

PLEASE READ THIS SECTION TO AVOID RISK OF SHOCK OR OTHER HAZARDOUS SITUATIONS.

1. Please handle the unit with extreme caution since the batteries contain large amounts of energy. Always store the unit in the orientation marked on the packaging.
2. Take extra care to avoid dropping the unit.
3. If flammable substances are present or if any gases or fumes are being emitted or if there is no ventilation in the place of storage or installation, a safety hazard exists and neither the unit or the extended battery packs should be operated in these environments.
4. The instructions in this manual detail how to install the UPS safely and correctly. Please read it thoroughly and keep this manual for future reference.



WARNING!

It is strongly advised that the UPS NOT be opened by anyone other than suitably qualified personnel. Dangerously high voltages are present within, regardless of whether the UPS is connected or not. In addition, the unit's output receptacles may contain live AC voltage even when not connected to the AC power supply since it contains its own energy source, (i.e. batteries).

User Allowable Operations

The only UPS-related operations that the user is allowed to perform are:

1. Turning the unit on and off.
2. Operating the user interface (function push-buttons and LCD panel).
3. Connecting data interface cables
4. Changing the batteries

All such operations are to be performed exactly as instructed in this manual. Any deviation from these instructions may prove hazardous and even fatal or may cause damage to the unit.

4. Storage

Please adhere to the following storage instructions if the UPS is not to be installed shortly after delivery:

1. Store the unit as is in its original packing and shipping container.
2. Store the unit within the following optimum temperature range: 59°F to 77°F (+15°C to +25°C).
3. Ensure that the equipment is fully protected from wet or damp areas and from moisture.
4. Ensure that the UPS is recharged every 6 months for at least 8 hours in order to maintain battery energy and maximize useable life.

5. Installation

5.1 System Configuration and Sizing

The internal electronics of the UPS plus the internal battery or batteries constitute the system. Please make sure that the following factors have been taken into consideration:

1. The total demand of the protected load determines the UPS power (VA) requirements. Allow some margin or headroom for future expansion or power requirement calculation inaccuracies.
2. Aside from power (VA) requirements, backup time needs to be considered. If the power consumed by the load is less than the nominal power rating of the UPS, then the actual backup time will be longer.
3. The following options are available, depending on application and load requirements:
 - a. External Battery Packs (EBPs) for extended run-times
 - b. Input/Output transformer cabinet
 - c. Maintenance bypass switch
 - d. Connectivity and control options (e.g. relay card, SNMP/WEB card)

Automatic Voltage Regulator/ Power Conditioner

Power interruptions and blackouts are relatively rare, but many other power quality issues still exist. In order to mitigate these other power problems, there is no need for energy storage. Therefore, a UPS with energy storage can also be configured as a battery-less, power conditioner/voltage regulator.

With a simple firmware change and removal of the standard batteries, the unit is converted to one that will take care of 8 of the 9 power quality issues.

This saves cost, weight, maintenance and makes them more environmentally friendly. The functionality of this version is identical to the version with batteries.

5.2 Environment

Ensure that all environmental requirements are met, otherwise the safety of installation personnel and users cannot be guaranteed. In addition, the unit may sustain damage or malfunction.

Please adhere to the following environmental instructions when locating the UPS and EBP's:

1. Avoid temperature and humidity extremes. The optimum operating temperature range is between 59°F and 77°F (+15°C and +25°C).
2. Provide protection against moisture or avoid altogether if possible.
3. Ensure there is at least 4 inches (100mm) behind and 2 inches (50mm) on each side of the UPS for ventilation.
4. Ensure that the front of the UPS remains unobstructed for access to the control panel and LCD display.
5. External Battery Packs must be installed next to or under the UPS.

WARNING!

Failure to follow these instructions may result in permanent damage to the UPS

MAINTENANCE BYPASS PROCEDURE (for Models without an Input Breaker)

1. Maintenance

- 1 Press the ON/OFF button to turn the UPS ON and it will go into "Line Mode". Press
- 2 the "Func" button on the front panel and hold for 3 seconds, then release, the UPS will go into "Function Setting Mode".
- 3 Toggle the "Func" button until the display shows "Manual Bypass" function and then press the "Enter" button to select it. The display will indicate "Bypass OFF".
- 4 Toggle the "Func" button again, the display will show "Bypass ON". Press the "Enter" button and this will put the UPS into "Manual Bypass mode".
- 5 Once the display indicates "Manual Bypass", rotate the "Bypass Switch" on the PTS from "UPS" position to "BYPASS" position.
- 6 Turn the UPS OFF.
- 7 Wait until the fan stops and then start maintenance work.

2. Restore

- 1 Press the ON/OFF button to turn the UPS ON and it will go into "Manual Bypass Mode".
- 2 Rotate the "Bypass Switch" on the PTS from the "BYPASS" position to the "UPS" position.
- 3 Press the "Func" button on the front panel and hold for 3 seconds, then release, the UPS will go into "Function Setting Mode".
- 4 Toggle the "Func" button until the display shows "Manual Bypass" function and then press the "Enter" button to select it. The display will indicate "Bypass ON".
- 5 Toggle the "Func" button again, the display will show "Bypass OFF". Press the "Enter" button and this will put the UPS back into "Line mode".

5.2 Rear Panel Views

5.2a Tower Models 700 / 1K / 1.5KVA Rear Panel Views

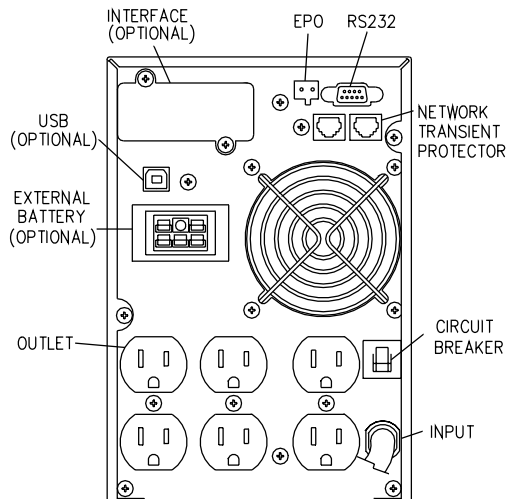

(120V NEMA)
Rear View 1

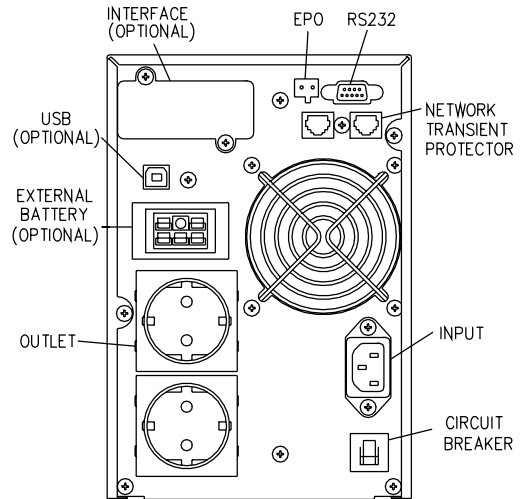

(220V G TYPE)
Rear View 2

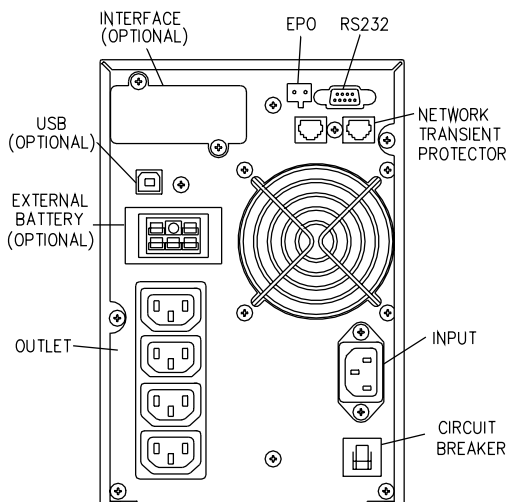

(220V IEC)
Rear View 3

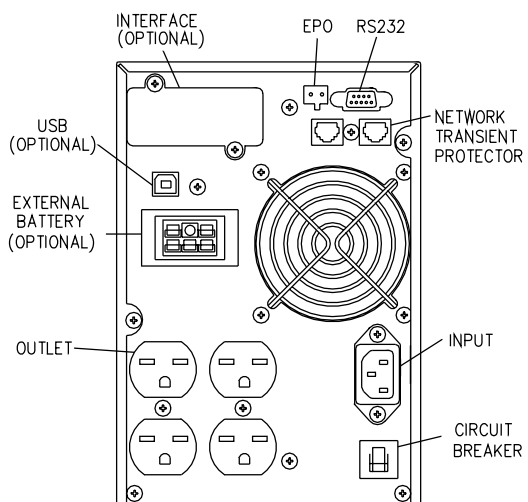

(220V NEMA)
Rear View 4

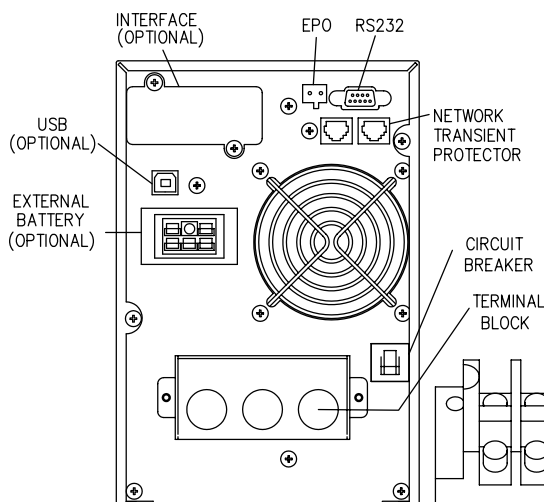

(HARDWIRE TERMINAL)
Rear View 5

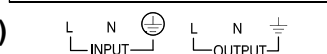

- VTWE-0700-01** Rear View 1
- VTWE-1000-01** Rear View 1
- VTWE-1500-01** Rear View 1
- VTWE-0700-02** Rear View 2, 3 or 4
- VTWE-1000-02** Rear View 2, 3 or 4
- VTWE-1500-02** Rear View 2, 3 or 4

A hardwire version of all models is available. For model number, substitute the last two digits of the model number for H1 (120V) or H2 (220V).

5.2b Tower Models 2K / 3KVA Rear Panel Views

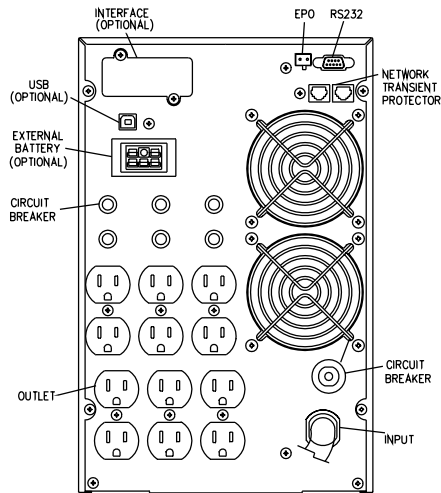

**(120V NEMA)
Rear View 6**

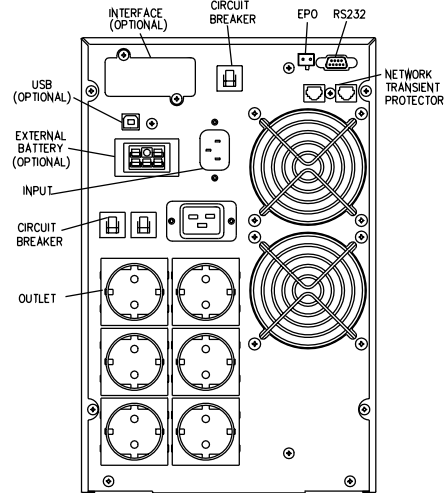

**(220V G TYPE)
Rear View 7**

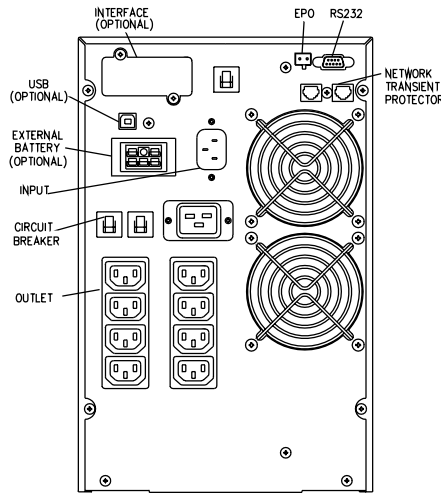

**(220V IEC)
Rear View 8**

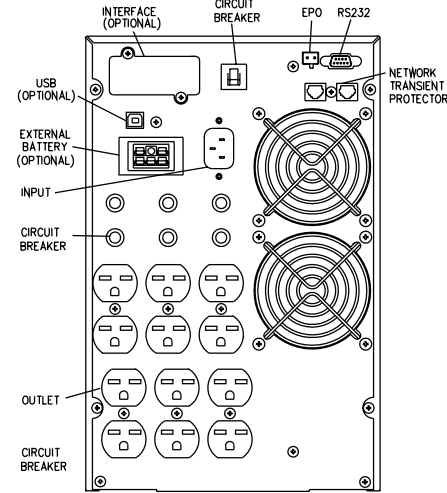

**(220V NEMA)
Rear View 9**

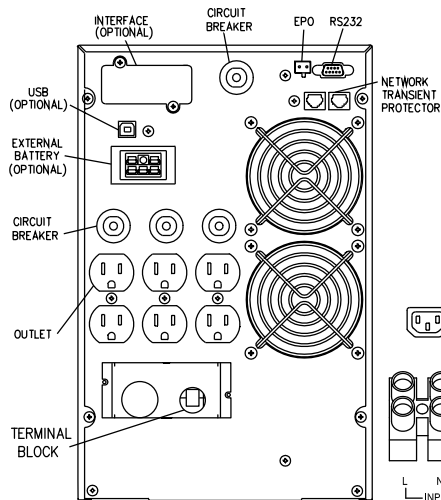

**(HARDWIRE TERMINAL)
Rear View 10**

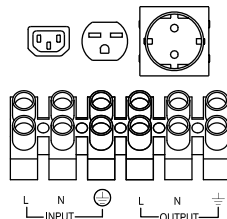

- VTWE-2000-01** Rear View 6
- VTWE-3000-01** Rear View 6
- VTWE-2000-02** Rear View 7, 8 or 9
- VTWE-3000-02** Rear View 7, 8 or 9

Different output receptacle options available

A hardwire version of all models is available. For model number, substitute the last two digits of the model number for H1 (120V) or H2 (220V).

5.2c 19" Rack Mount Models (1U) 700 / 1KVA Rear Panel Views

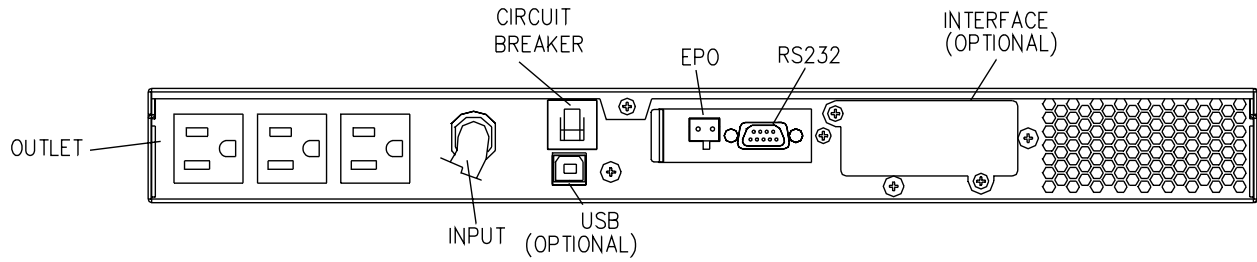

(RM-1U 120V NEMA) Rear View 11

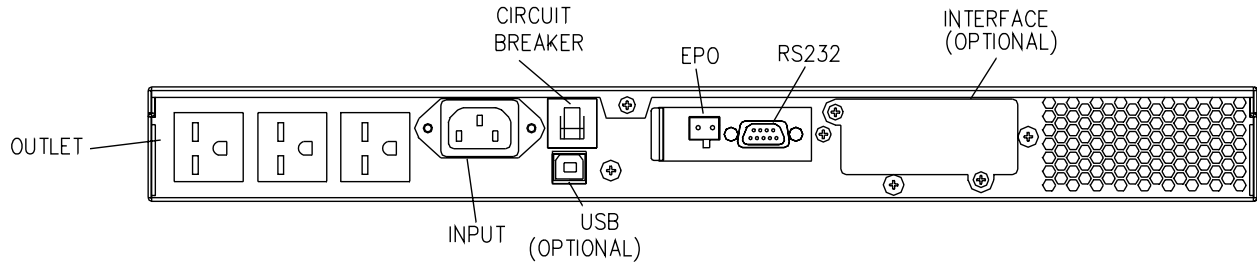

(RM-1U 220V NEMA) Rear View 12

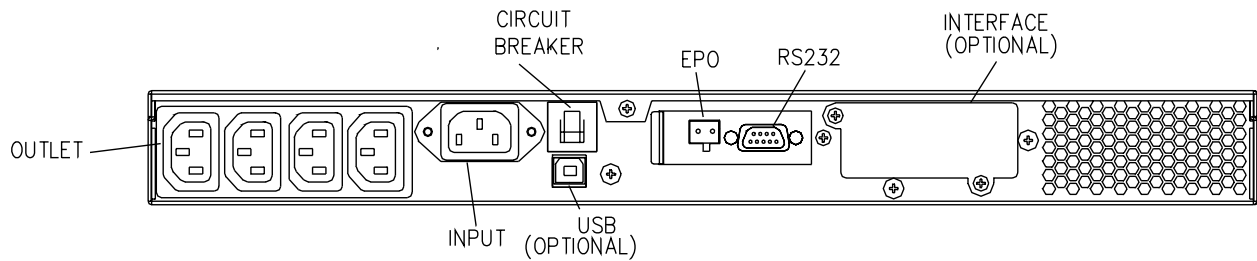

(RM-1U 220V IEC) Rear View 13

VRME-0700-01 Rear View 11

VRME-1000-01 Rear View 11

VRME-0700-02 Rear View 12 or 13

VRME-1000-02 Rear View 12 or 13

5.2d 19" Rack Mount Models (2U) 700 / 1K / 1.5KVA Rear Panel Views

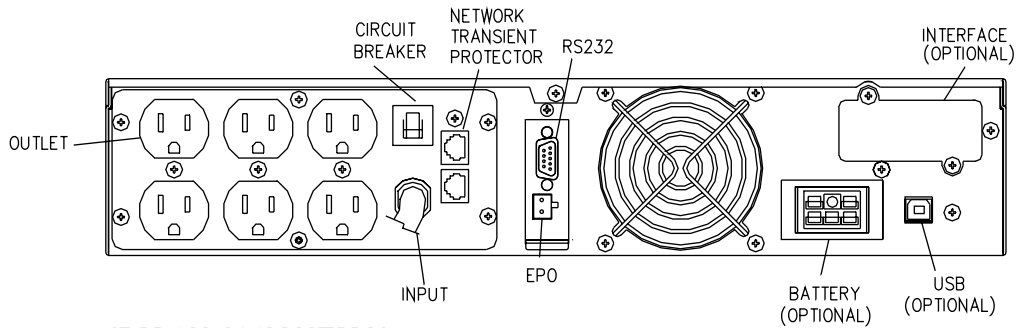

(RM-2U 120V NEMA) Rear View 14

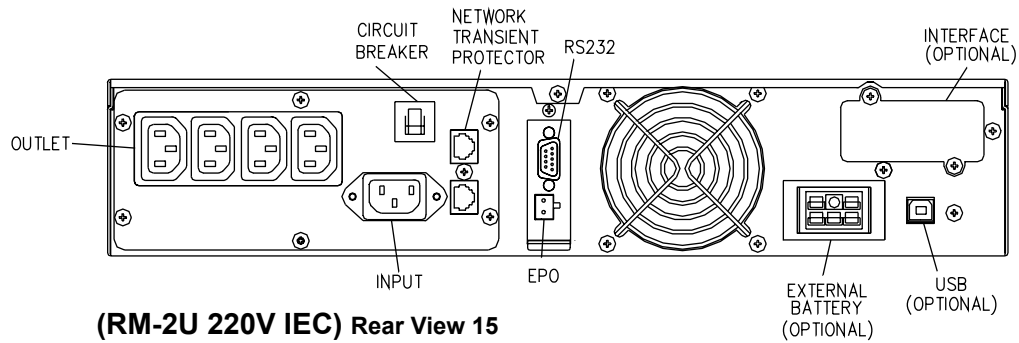

(RM-2U 220V IEC) Rear View 15

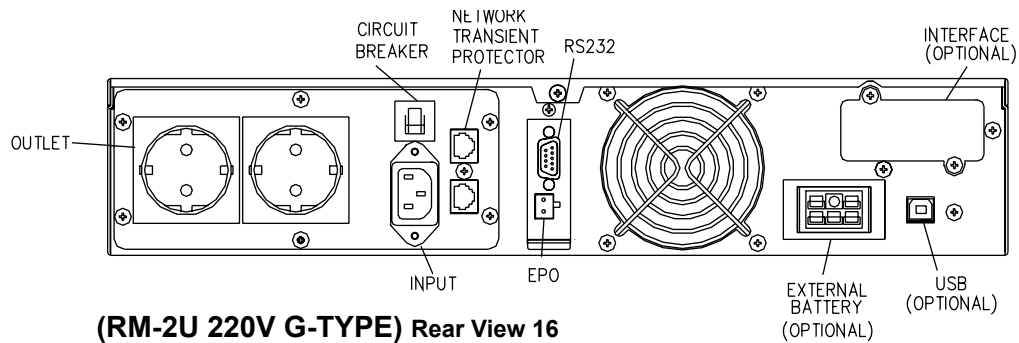

(RM-2U 220V G-TYPE) Rear View 16

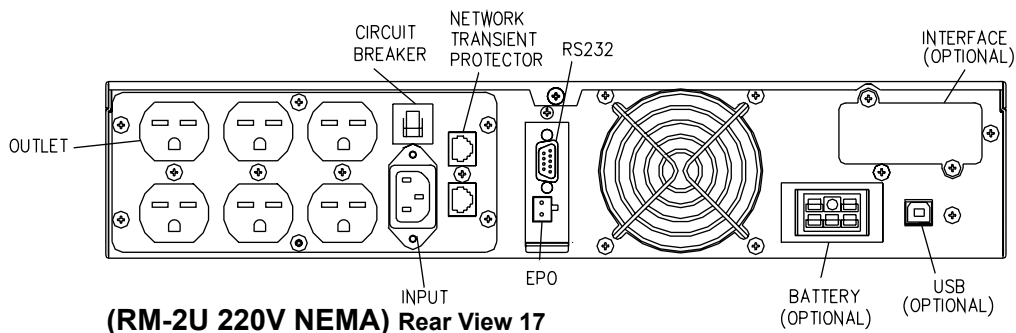

(RM-2U 220V NEMA) Rear View 17

A hardware version of all models is available. For model number, substitute the last two digits for H1 (120V) or H2 (220V).

VRTE-0700-01 Rear View 14
VRTE-1000-01 Rear View 14
VRTE-1501-01 Rear View 14

VRTE-0700-02 Rear View 15, 16 or 17
VRTE-1000-02 Rear View 15, 16 or 17
VRTE-1500-02 Rear View 15, 16 or 17

5.2e 19" Rack Tower Models (2U) 2K / 3KVA Rear Panel Views

(RM-2U 120V NEMA)

Rear View 18

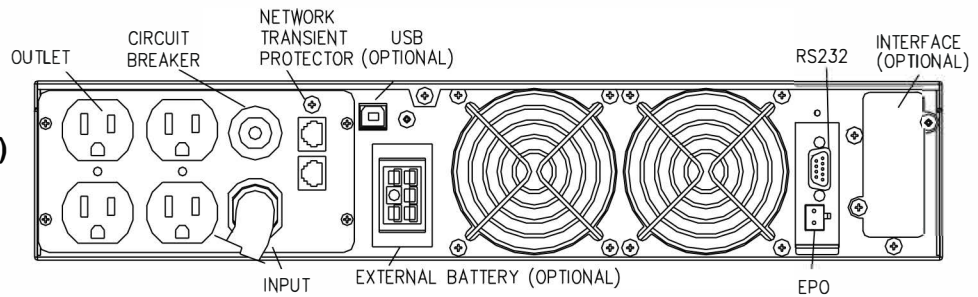

(RM-2U 220V IEC)

Rear View 19

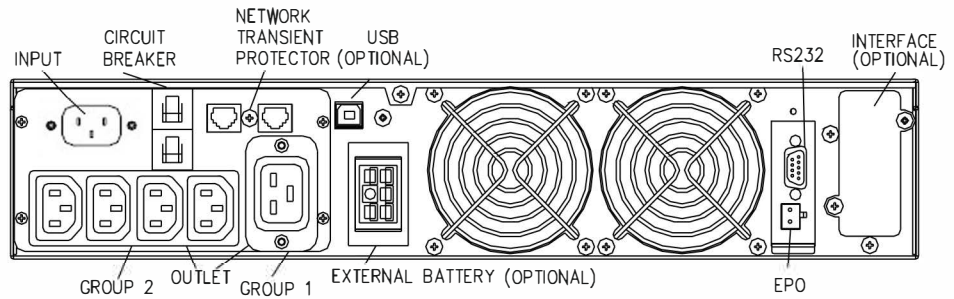

(RM-2U 220V G-TYPE)

Rear View 20

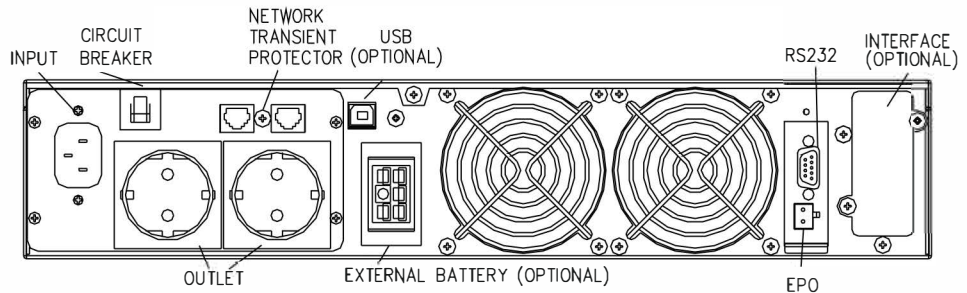

(RM-2U 220V NEMA)

Rear View 21

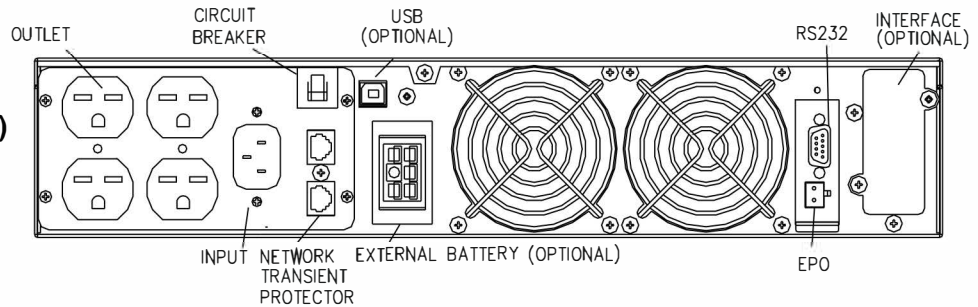

**(HARDWIRE
TERMINAL)**

Rear View 22

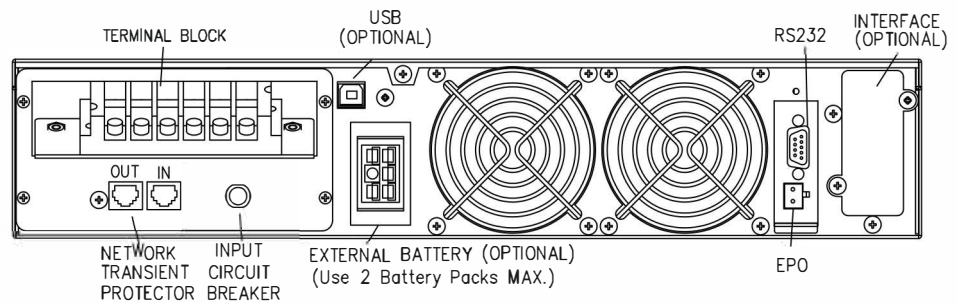

A hardwire version of all models is available. For model number, substitute the last two digits for H1 (120V) or H2 (220V).

VRTE-2000-01 Rear View 18

VRTE-2000-02 Rear View 19, 20 or 21

VRTE-3000-01 Rear View 18

VRTE-3000-02 Rear View 19, 20 or 21

5.3 AC Power and Load Connections

Various input (and sometimes output) cables are supplied with all models:

1. Ensure that the UPS is disconnected from the AC power supply when connecting External Battery Packs.
2. Use the battery cable that is supplied with the External Battery Pack when connecting it to the UPS. Then connect the second battery cabinet to the first and so forth, assuming more than one is to be added.
3. Take note of UPS parameters when adding external battery packs and adjust accordingly (see Chapter 7)
4. Connect the input cable to the UPS and connect the other end to a grounded AC power outlet. The batteries will automatically begin to charge. Please note that while the UPS may be used immediately, maximum back-up time may not be available until the batteries have been charged for a minimum of 8 hours.
5. If the unit displays "Site Wiring Fault", have the wiring fault corrected.
6. After initial charging is complete, connect the loads to the UPS (see example in Fig 2 below).
7. Do not connect any load that may overload the UPS such as equipment containing AC electric motors or loads that have a high inrush current.
8. Make computer and/or alarm interface connections according to Chapter 6 of this user manual and that provided with the interface option. These connections are made on the rear panel.
9. Installation is now complete.

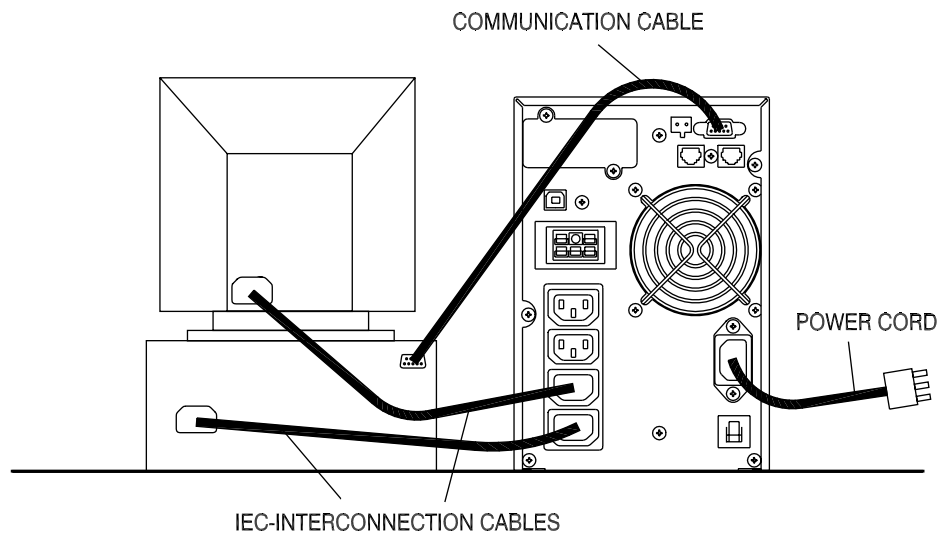

Fig. 2 Connection example

5.4 Connecting an Extended Run-Time Battery Pack

Please refer to the Extended Run-Time Battery Pack user manual for detailed instructions.

5.5 Factory Default Settings

The following table shows the factory default settings for all UPS parameters as well as user selectable options. It is recommended that changes be made shortly after installation but prior to connection of the load/s.

Parameter	Options	Factory Default Setting
Output Voltage	100/110/115/120/127 VAC	120V
	208/220/230/240 VAC	220V
Input/Bypass Voltage Tolerance	±10% +10/-15% +15/-20%	+10/-15%
Input/Frequency Tolerance	±2% ±5% ±7%	±5%
High Efficiency Mode Setting	On/Off	Off
Free Run Mode	On/Off	On
Bypass In Free Run Mode	Disable/Enable	Disable
Alarm Silence	On/Off	Off
Site Wiring Fault	Enable/Disable	Disable
External Battery Pack Quantity	0, 1, 2	0

6. Communication Interface and Alarm Connections

6.1 Overview

All models are available with various interfaces which allow direct communication with, and control of, the computer. There is a choice of an RS-232 serial data interface, a USB data interface and an EPO (Emergency Power Off) connector. NOTE: The RS-232 port cannot be used when the USB interface is in use.

There is also an optional interface slot that allows for the installation of additional communications cards which can be used parallel with either the RS-232 or USB ports.

There are currently two cards available; an SNMP/WEB card which allows UPS management and power monitoring over a network or the internet and an AS/400 card which contains voltage-free relay contacts. Please contact tech support for more information on these options.

6.2 Connecting the UPS to a Computer

The communication cable that is supplied with the UPS is the ONLY one that should be used with it. Other cables may not work and may cause improper operation or the unit to malfunction.

Some options may come as a complete package containing a different cable, different power management software and additional hardware (i.e. interface card).

Please ensure that your operating system is supported by the provided software. Detailed software installation instructions are provided with or within the power management software.

6.3 RS-232 Interface Port (Standard)

The RS-232 interface uses a 9-pin female D-sub connector. This information consists of data regarding utility (AC) power, the load and the UPS. The interface port pins and their functions are identified in the following table:

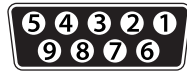

Pin#	Signal	Direction (UPS)	Functions
2	TxD	Output	TxD Output
3	RxD	Input	RxD / Inverter Off Input
5	Common		Common
6	CTS	Output	AC Failure Output
8	DCD	Output	Low Battery Output
9	RI	Output	+8-24 VDC Power

NOTE: Maximum rating is 24VDC / 50mA

6.4 USB Port

Connecting the UPS to the computer is accomplished using a free USB port on the computer. A USB compliant operating system is necessary as well as hardware and the installation of a UPS driver. The serial port cannot be used when using the USB port. The required USB cable comes with the UPS when this option is specified. Connection is shown in Fig. 2.

6.5 EPO Port (Emergency Power Off)

The EPO port allows an immediate emergency shutdown to be activated remotely by disconnecting and removing power from the UPS output. Any manual or automatic shutdown procedures including those directed by power management software, are overridden. To activate, make sure the UPS and loads are first turned off. Remove the jumper from the EPO connector, and connect an insulated dry contact (NC, 60VDC, 30VAC, 20mA) to the EPO port.

6.6 Network Transient Protector (Optional)

The network transient protector, located on the rear panel, consists of both IN and OUT jacks housed on a separate RJ-45 (10BaseT) network card. If used, make sure that the input and the output are connected to the appropriate jack.

6.7 Load Segments

The power management software controls individual sets of output receptacles on the UPS called "load segments" which provide controlled and sequential startup and shutdown of loads. Less critical equipment can be turned off during power outages saving battery power for more critical loads. Load segment status can be viewed from the LCD display on the UPS and can be changed if necessary. Load segments are usually controlled by the UPS management software.

7. Operational Instructions

7.1 Starting Up and Shutting Down the UPS

Start Up



1. Ensure that the unit has been correctly installed and that the input power cable is connected to a properly grounded AC outlet.
2. The unit is turned on by pushing the power push-button on the front panel for more than 3 seconds.
3. The unit sequences through its functional check, AC line synchronization and inverter startup. Power is then applied to the outlets.
4. During this sequence, the LCD panel displays "Ready On". An LED illuminates when output power is available and the LCD panel displays "Line mode".
5. The loads can now be turned on.

Shut Down

1. Shut down and turn off all connected loads.
2. Push the power push-button on the front panel for five seconds or more. An audible alarm will sound and the unit will shut down.
3. The LCD panel displays "UPS OFF" for a few seconds.
4. In emergency situations or applications which require such, the EPO located on the back of the unit should be used.

7.2 Push-button Operations

There are three operational push-buttons on the front panel:

1.  **Power** - This push-button turns the unit on and off. To initiate a start-up or shut-down, press and hold this push-button for 3 seconds.
2.  **Enter** - This push-button is used to check current UPS and load settings, information and power measurements. To activate, press it for at least 2 seconds. There are 15 different readings that can be checked in this mode and pressing this push-button once each time scrolls through each reading. If the push-button is not pressed within 5 seconds, the display reverts to its original mode.
3.  **Function/Scroll** - This push-button selects or enables various user-selectable parameters. There are 14 different parameters which can be scrolled through. To activate, press it for at least 2 seconds. After locating a setting or particular parameter, press the Enter push-button to select that parameter and view its current setting. Press the Function push-button once again to scroll through the setting options. Once the desired setting is located, press the Enter push-button to enable the new setting and once again to save it (you will be prompted to do so). If no action is taken within 10 seconds, the display reverts to its previous mode.

7.3 Control Panel Indicators

Status, parameters and readings are displayed on the control panel via five LED indicators and/or an LCD screen and audible alarms compliment the display.

- ON**  This symbol is accompanied by a green LED that illuminates when the UPS has been turned on.

- ON-LINE**  This symbol is accompanied by a green LED that illuminates when the UPS is in normal or static bypass mode and AC voltage is present at the output terminals.

- ON-BAT**  This symbol is accompanied by a yellow LED that illuminates when the UPS is operating in battery mode.

- BYPASS**  This symbol is accompanied by a yellow LED that illuminates when the UPS is operating in bypass mode.

- FAULT**  This symbol is accompanied by a red LED that illuminates if an internal UPS error occurs. An audible alarm also sounds but can be muted by pressing any of the push-buttons on the front panel.

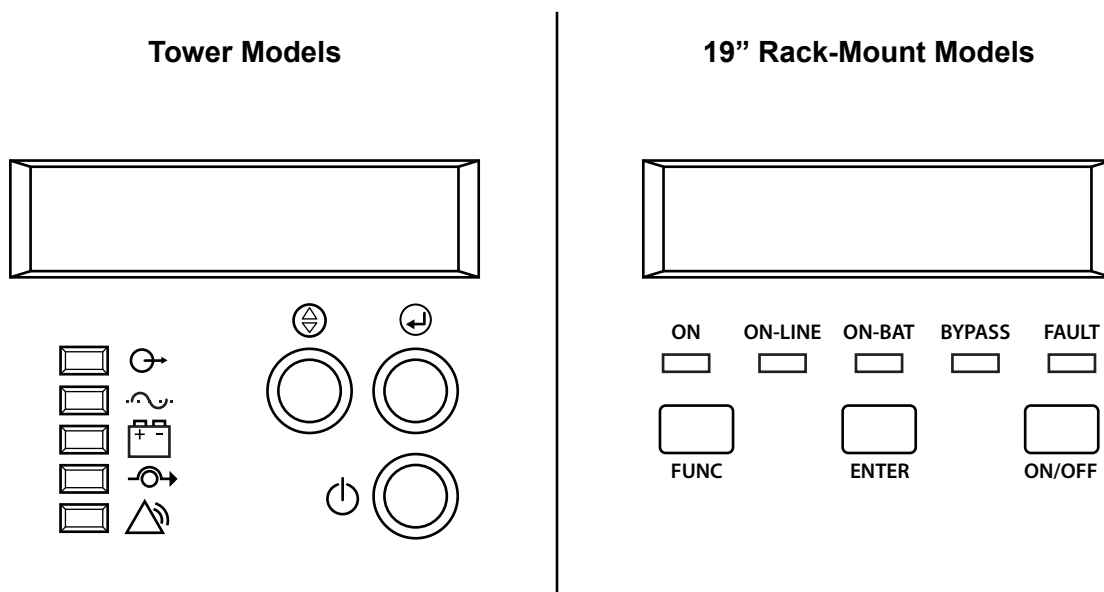

Fig. 3 Control panel

7.4 LCD Panel Display Modes

1. Normal Display Mode

UPS status is shown in this display mode. From this mode, the UPS data display mode and the setting display mode can be selected by pressing the appropriate push-button.

2. Data Display Mode

Various data and measurements are shown in this display mode. Pressing the Enter push-button (for 2 seconds to activate) scrolls through the following data:

Parameter	Indicates
O/P VOLT = xxx,x V	Output AC voltage
O/P FREQ = xx,x Hz	Output Frequency
I/P VOL T = xxx,x V	Input AC voltage
I/P FREQ = xx,x Hz	Input Frequency
BAT VOLT = xx,x V	Battery Voltage
O/P LOAD% = xx %	Load expressed as a percentage of the maximum load
O/P W = x W	Output Watts
O/P VA = x VA	Output VA
O/P CURR = x A	Output Current
BACKUP TIME = xx min	Estimated Backup time in minutes
BAT CHARG = xx %	Approximate Battery capacity expressed as a percentage
TEMPERATURE = xx °C	Approximate ambient temperature
BAT PACK NUM = x	External Battery Pack quantity
RATING = xxxx VA U	UPS Rating
CPU VERSION = xx.x	CPU Version

3. Configuration/Setting Display Mode

1. The current UPS configuration/settings are shown in this mode.
2. To enter this, press the Function/Scroll push-button for one second. The first configuration parameter will be shown on the LCD display.
3. Press the Function/Scroll push-button to scroll through each parameter.
4. Press the Enter push-button to select the parameter.
5. Press the Function/Scroll push-button to scroll through the options for the selected parameter.
6. Press the Enter push-button to select the option. You will be prompted to save the selection, so pressthe Enter push-button to confirm and save your selection. See the table below for further details.
7. If no action is taken within 10 seconds, the display reverts to normal display mode.

Settings	LCD Display	Detail	Selection/Option Default	
Output Voltage	O/P V Setting	Nominal Voltage Selection	208/220/230/240 V	220V
			100/110/115/120/127 V	120V
Input/Frequency	I/P F Setting	Input frequency range selection when UPS is in free run mode	±2% ±5% ±7%	±5%
Input/Bypass Voltage	I/P Bypass Set	Input Voltage range selection when bypass is available	±10% +10/-15% +15/-20%	+10/-15%
Free Run Mode	Free Run Set	UPS run in Free run mode selection (unsynchronized)	ON/OFF	ON
Bypass Enable/Disable in Free run Mode	Bypass disable	Allows the UPS to go into bypass mode when unsynchronized.	Disable/Enable	Disable
High Efficiency Mode	HE Mode Set	Allows the UPS to run in high efficiency mode	ON/OFF	OFF
Manual Bypass Force	Manual Bypass	Forces the UPS into bypass mode. (For service only)	ON/OFF	OFF
Load Segment / Group Management	Outlet Setting	Allows load group/segments to be turned on and off from the front panel	1 ON & 2 ON 1 OFF & 2 ON 1 OFF & 2 OFF 1 ON & 2 OFF	1 ON & 2 ON
Initiate Battery Test	Battery Test	Detects whether battery is in good condition or not.		
Alarm Silence	Silence Set	Enables or disables alarm silencing	ON/OFF	OFF
External Battery Pack Quantity	Bat Cabinet Set	Allows the UPS to more accurately determine remaining backup time	0 (only internal batteries) 1 (one external cabinet) 2 (two external cabinets)	0
Site Wiring Fault Alarm	Sit Fault Set	Enables or disables site wiring fault alarm	Enable /Disable	Disable
Language	Language	Selects load language	English, German, French, Spanish, Italian.	English
Generator Mode	Generator	Places UPS in generator mode ***	ON/OFF	OFF
RS-232 communication	RS232 Control	Enables or disables RS-232 communication capability	Enable/Disable	ENABLE

7.5 Manual UPS or Battery Test

A manual UPS or battery test can be initiated from the UPS configuration/settings display and can be carried out even when the UPS is not charging the battery. To initiate, scroll through the parameters until Manual Bat test is displayed on the LCD panel. Press the Enter push-button twice.

** NOTE: In order for the UPS and power management software to function correctly, Manual Bypass should always be set to OFF as the load will not be protected by the UPS when Manual Bypass is ON.

*** NOTE: The UPS should be turned off but kept connected to the AC power supply before activating the Generator Mode.

7.6 Audible Alarms

1. If the UPS is on battery and the “ON BATTERY” LED is illuminated, the unit will beep every 5 seconds.
2. If the battery capacity is low and the “ON BATTERY” LED is flashing, the unit will beep twice every 5 seconds.
3. If the UPS is in bypass mode and the “BYPASS” LED is illuminated, the unit will not beep.
4. If the UPS has an internal fault and the “ALARM” LED is illuminated, the unit will emit a constant alarm tone and display the cause of the fault on the LCD panel.
5. To silence an alarm, press any of the three push-buttons on the front panel. The alarm will be silenced under all conditions except when the battery is low, under which condition the alarm cannot be silenced.
6. The audible alarm function can be de-activated internally by selecting the appropriate parameter from the LCD panel.

7.7 Trouble shooting

LCD Dis.	Audible Alar.	Problem Description	Corrective Action
Output Overload	Two beeps per second	The UPS is overloaded (in Line Mode). The power rating of the connected equipment exceeds the capacity (VA rating) of the UPS. The UPS operates in bypass mode.	Reduce the load on the UPS by disconnecting less critical equipment. Once the total load is below the maximum specified by the UPS, it will switch from bypass back to normal mode.
Battery Test	No audible tone	The UPS is performing a battery test.	No action required. The UPS will resume normal operation once the battery test has been successfully completed.
Over-Charge	Constant audible tone	The batteries have been over-charged.	Turn off protected loads, then turn off the UPS and contact tech support.
Low Battery	Two beeps every 5 seconds	The unit is operating on battery power but will shut down shortly due to low battery voltage.	Initiate a controlled shutdown of connected equipment immediately. The UPS will restart automatically once AC power has been restored.
On-Battery	One beep every 5 seconds	The unit is operating on battery power.	No action required. A controlled shutdown of connected equipment can be initiated if necessary.
Charger Failure	Constant audible tone	Battery charger failure.	Turn off protected loads, then turn off the UPS and contact tech support.
Over-Temperature	Constant audible tone	High ambient temperature.	Check that the UPS cooling fans and ventilation holes are not blocked. Check that the ambient temperature surrounding the UPS is not above 104°F (40°C). If these conditions do not exist but the problem persists, contact tech support.
Output Short Circuit	Constant audible tone	Output short circuit.	Turn off protected loads, then turn off UPS and contact tech support.
High Output Voltage	Constant audible tone	Output voltage too high.	Turn off protected loads, then turn off UPS and contact tech support.
Low Output Voltage	Constant audible tone	Output voltage too low.	Turn off protected loads, then turn off UPS and contact tech support.
Bus Fault	Two beeps per second	Internal DC bus voltage too high.	Turn off protected loads, then turn off UPS and contact tech support.
Site Wiring Fault	One beep per second	Incorrect AC power connection polarity. Ground connection missing or faulty.	Have the wiring fault corrected or alternately, disable the related alarm on the UPS
Line Abnormal	One beep per second	Incorrect AC Line backed up during auto restart.	Connect correct AC power line.

FOR ADDITIONAL ASSISTANCE, PLEASE CONTACT US AT 310-689-2328 OR SUPPORT@MARATHON-POWER.COM

8. Maintenance

As long as all the installation, environmental and operational requirements have been followed and met, the UPS will require little or no maintenance for many years. The batteries are the only component that should eventually need replacing. Their useful life depends primarily on the following two factors; the ambient temperature of the environment in which the UPS is located and the number of times they're called into use (i.e. discharged). In both cases, the lower the number, the longer they will last. At an ambient temperature of 77°F (25°C), typical battery lifetime is 3-5 years. A test of the UPS and batteries should be carried out at regular intervals (every 6 to 12 months) to verify that back-up time is still adequate for the application. The UPS should also be charged every six months if it is kept in storage and not used.

8.1 Battery Replacement

Since the batteries are "Hot-Swappable", they can be replaced without having to turn the UPS off or disconnecting the load.



WARNING!

Batteries may cause electrical shock or burn from high short circuit currents. Please observe the following precautions when working with them:

- 1. Remove jewelry and metal objects such as watches and rings.**
- 2. Use tools that have insulated handles.**
- 3. Prevent tools and other metal objects from coming into contact with the batteries.**
- 4. Batteries can pose an electric energy hazard. Do not rewire, modify, or change any battery wiring or connections. Such modifications can cause serious injury and/or damage.**
- 5. Replace with the same type, rating and quantity as the original batteries.**
- 6. Do NOT disconnect the batteries while the UPS is in Battery mode.**

The following procedure applies to both Tower (Fig. 4) and 19" Rack-Mount (Fig. 5) models:

1. The front panel of the UPS can be removed by pulling or gently prying it off at the locations indicated and in the direction shown in the following diagrams. **STEP 1. CAUTION:** Be careful not to pull the cover abruptly or too far forward as there is a ribbon cable that supplies the LCD display connecting it to the UPS
2. Once the cover has been removed and rotated out of the way, remove the screws securing the metal battery cover and set them and the cover aside in a safe place. **STEP 2.**
3. Slowly slide the battery cartridge out from the UPS. **STEP 3.**
4. Disconnect each battery within taking note of each one's physical orientation, polarity and mechanical connections.
5. Replace the batteries and reconnect them according to the details noted in step 4.
6. Carefully slide the battery cartridge containing the new batteries back in making sure it goes in all the way and "clicks" into place.
7. Reinstall the metal battery cover and then the front panel.

Battery Replacement Procedure Diagram for Tower Models

View battery installation video: <https://youtu.be/n9H1bL1gYMw>

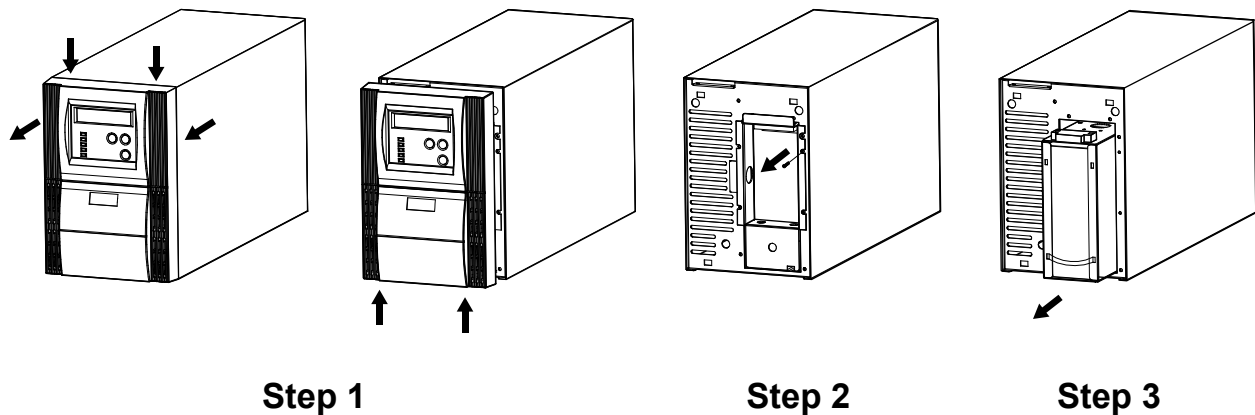

CAUTION: Take care when removing the front cover as there is a ribbon cable attached to the cover from the UPS!

Fig.4

Battery Replacement Procedure Diagram for 19" Rack-Mount Models

View battery installation video: <https://youtu.be/mbCtd2ShaAU>

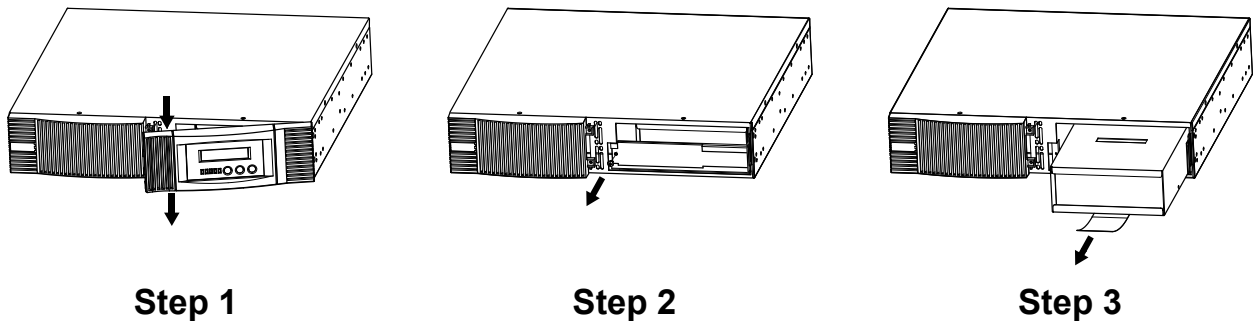

CAUTION: Take care when removing the front cover as there is a ribbon cable attached to the cover from the UPS!

Fig.5

8.2 Storage Requirements

Store the UPS covered, upright and in a cool, dry location, with its battery fully charged. Before storing, charge the UPS for at least 8 hours. During extended storage in environments where the ambient temperature is +5 to +86°F (-15 to +30°C), charge the UPS's battery every 6 months. During extended storage in environments where the ambient temperature is +86 to +113°F (+30 to +45°C), charge the UPS's battery every 3 months.

8.3 Maintenance and Precautions

Harsh Environments:

Marathon Power Standard UPS's are generally designed for clean environments, free of dust, salt, and other environmental contaminants. Some of the harmful effects of environmental contamination are as follows:

- Dust, chemicals and airborne pollutants can clog and corrode the inside of a UPS and lead to failures.
- Installing a UPS in a harsh environment leads to overheating, and damage to internal boards, components, etc. It can also create arc flashes which can be very dangerous to anyone in close proximity to the UPS. Arc flashes are a shock hazard to anyone nearby and could potentially cause serious injury or death.
- Salt from humid, ocean air can also corrode the internal components of a UPS as well as the batteries. This can cause premature failure of parts/components and lead to electrical short circuits.
- Adding fan filters to the cooling fan is not recommended because the cooling fan in these units is an exhaust fan. The cooling fan/s are located on the rear panel and rotate to create negative pressure as it draws in fresh air through the ventilation slots on the front and or side of the UPS cabinet. This air exits the UPS system through the cooling fan on the rear panel. Therefore, adding fan filters to the exhaust fan/s will not stop dust and fibers from entering through the ventilation slot.

Precautionary Measures:

If our products must be used in harsh environments, the following must be performed:

Vacuuming: Properly clean the UPS by vacuuming and cleaning it thoroughly, periodically (every 3 to 6 months).

1. Do not use vacuum cleaners with a very strong suction. The vacuum hose needs to be about one inch away from the components and should not touch them.
2. Use a plastic brush about 2 inches long, with soft bristles to dislodge and remove dust and debris from the surface of the PCBA and components.
3. This should be followed by the use of computer-grade compressed air duster to blow out the dust.

Conformal coating: Adding a protective layer to the internal components can protect the UPS. Conformal coating is used for enhanced protection in harsh environments such as mentioned in this document. It is a resin that is added to the PCBA and it forms a thin film or protective clear coating. (Available upon request).

Additional Notes:

- The UPS should not be used in hazardous locations as defined in National Electrical Code (NFPA 70).
- The ambient temperature should be within +32 °F ~ +104 °F / 0 °C ~ +40 °C.
- For safety during servicing, the UPS needs to be turned Off and unplugged from AC input power and the internal battery should be temporarily disconnected.

9. Specifications

9.1 120V Models

GENERAL

Rated Capacity: 700VA, 1000 VA, 1500 VA, 2000 VA, 3000 VA with a power factor of 0.7
Technology: True on-line, double conversion topology with integral automatic bypass

INPUT

Phase: Single phase plus ground
Input Bypass Voltage: 96 - 138 VAC (+15% to -20% of 120V nominal - user selectable)
Input Voltage range: 60 / 70 / 80VAC - 144 VAC
(60-144V @ 40% load, 70-144V @ 70% load, 80-144V @ 100% load) 50 / 60
Frequency: Hz Auto sensing
AC Frequency range: 45 - 65 Hz
Synchronization range: \pm 3Hz
Input Current: 700VA - 4.78, 1000VA - 6.83, 1500VA - 10.25, 2000VA - 13.66, 3000 VA - 20.50
Input Power factor: 0.97

OUTPUT

Output Voltage: 120V (Default) 100 / 110 / 115 / 120 / 127 VAC (user selectable)
Voltage regulation: \pm 2%
Voltage distortion: < 5% THD with non-linear loads, < 3% THD with linear loads
Frequency regulation: \pm 0.25 Hz (while on battery or in free run mode)
Dynamic response: \pm 9 % max from 100% to 20 % or from 20% to 100 % linear load
Overload capacity: 100 - 125% for 1 min, 125 - 150% for 10 sec
Efficiency (HE Mode): Greater than 95%
Efficiency (On-line Mode): Greater than 86%
Crest Factor: 3 : 1

9.2 230V Models

GENERAL

Rated power: 700VA, 1000 VA, 1500 VA, 2000 VA, 3000 VA with a power factor of 0.7
Technology: True on-line, double conversion topology with integral automatic bypass

INPUT

Phase: Single phase plus ground
Bypass Voltage: 184 - 265 VAC (user selectable)
Input Voltage range: 120 / 140 / 160 VAC - 276 VAC
(120V @ 40%, 140V @ 70%, 160V @ 100% load)
Frequency: 50 / 60 Hz Auto-sensing
AC Frequency range: 45 - 65 Hz
Synchronization range: \pm 3Hz
Input Current: 700VA - 2.49, 1000VA - 3.56, 1500VA - 5.34, 2000VA - 7.13, 3000VA - 10.69
Input Power factor: 0.97

OUTPUT

Output Voltage: 220V (Default) 208 / 220 / 230 / 240 VAC (user selectable)
Voltage regulation: \pm 2%
Voltage distortion: < 5% THD with non-linear loads, < 3% THD with linear loads
Frequency regulation: \pm 0.25 Hz (while on battery or in free run mode)
Dynamic response: \pm 9 % max from 100% to 20 % or from 20% to 100 % linear load
Overload capacity: 100 - 125% for 1 min, 125 - 150% for 10 sec
Efficiency (HE Mode): Greater than 95%
Efficiency (On-line Mode): Greater than 86%
Crest Factor: 3 : 1

9.3 All Models

ENVIRONMENTAL

Ambient temperature range:	+32 °F to +104 °F	(+0 °C to +40 °C)
Optimum temperature range:	+59 °F to +77 °F	(+15 °C to +25 °C)
Storage temperature:	+5 °F to +122 °F	(-15 °C to +50 °C)
Cooling:	Forced air cooling	
Humidity:	0-95%, non-condensing	
Elevation:	10,000 feet max (operation), 45,000 feet (storage)	
Audible noise:	< 45 db normal and battery mode (700-1000 VA models) < 50 db normal and battery mode (1500-3000 VA models)	

STANDARDS

Safety:	EN62040-1 (230V) ; UL1778 (120V)
Emissions:	EN62040-2 (230V), FCC Part 15 Subpart B (120V)
Immunity:	EN62040-2 ; Category C1 (1000VA, 1500VA 230V only) EN62040-2 ; Category C2 (2000VA, 3000VA 230V only)
Conformity (120V):	UL 1778 5th Edition
Conformity (230V):	CE
Transient Immunity (120V):	Per IEEE 62.41 (formerly IEEE 587)
Transient Immunity (230V):	Per IEEE IEC 61000-4-5 level 3

MODEL & PART NUMBER DESIGNATION

Plug & Receptacle Version

120V Tower Models: VTWE-0700-01, VTWE-1000-01, VTWE-1500-01, VTWE-2000-01, VTWE-3000-01
230V Tower Models: VTWE-0700-02, VTWE-1000-02, VTWE-1500-02, VTWE-2000-02, VTWE-3000-02
120V Rack-Tower Models (1U): VRME-0700-01, VRME-1000-01
230V Rack-Tower Models (1U): VRME-0700-02, VRME-1000-02
120V Rack-Tower Models (2U): VRTE-0700-01, VRTE-1000-01, VRTE-1501-01, VRTE-2000-01, VRTE-3000-01
230V Rack-Tower Models (2U): VRTE-0700-02, VRTE-1000-02, VRTE-1500-02, VRTE-2000-02, VRTE-3000-02

Hardwire Terminal Version

120V Tower Models: VTWE-0700-H1, VTWE-1000-H1, VTWE-1500-H1, VTWE-2000-H1, VTWE-3000-H1
230V Tower Models: VTWE-0700-H2, VTWE-1000-H2, VTWE-1500-H2, VTWE-2000-H2, VTWE-3000-H2
120V Rack-Tower Models (2U): VRTE-1000-H1, VRTE-1501-H1, VRTE-2000-H1, VRTE-3000-H1
230V Rack-Tower Models (2U): VRTE-1000-H2, VRTE-1500-H2, VRTE-2000-02, VRTE-3000-H2

Twist Lock Output Receptacle Version

120V Tower Models: VTLE-1000-01, VTLE-1500-01, VTLE-2000-01, VTLE-3000-01
120V Rack-Tower Models: VRLE-1000-01, VRLE-1500-01, VRLE-2000-01, VRLE-3000-01

Automatic Voltage Regulator / Power Conditioner Version

120V Tower Models: VTWA-0700-01, VTWA-1000-01, VTWA-1500-01, VTWA-2000-01, VTWA-3000-01
230V Tower Models: VTWA-0700-02, VTWA-1000-02, VTWA-1500-02, VTWA-2000-02, VTWA-3000-02
120V Rack-Tower Models (2U): VRTA-0700-01, VRTA-1000-01, VRTA-1500-01, VRTA-2000-01, VRTA-3000-01
230V Rack-Tower Models (2U): VRTA-0700-02, VRTA-1000-02, VRTA-1500-02, VRTA-2000-02, VRTA-3000-02

120V Tower Models

Model Number	VTWE-0700-01	VTWE-1000-01	VTWE-1500-01	VTWE-2000-01	VTWE-3000-01
Capacity	700VA 490W	1000VA 700W	1500VA 1050W	2000VA 1400W	3000VA 2100W
Input Plug	NEMA 5-15P	NEMA 5-15P	NEMA 5-15P	NEMA 5-20P	NEMA L5-30P
Input Connection	Fixed Power Cord				
Output Connection	6 x NEMA 5-15R			12 x NEMA 5-15R	
Battery Type & Rating	Sealed, lead-acid 7.2Ah/12V	Sealed, lead-acid 7.2Ah/12V	Sealed, lead-acid 9Ah/12V	Sealed, lead-acid 7.2Ah/12V	Sealed, lead-acid 9Ah/12V
Battery Quantity	2	3	3	6	6
Backup Time (full load)	7 min	6 min	5 min	6 min	5 min
Recharge Time	<4 hours to 90 %				
Dimensions in / mm W x D x H	6 x 16.5 x 9.4 152 x 420 x 238			8.9 x 16.7 x 14.2 225 x 425 x 360	
Weight lbs. / kg	29.7 / 13.5	35.7 / 16.2	37.4 / 17	69.5 / 31.6	72.6 / 33

120V 19" Rack Mount Models (2U)

Model Number	VRTE-0700-01	VRTE-1000-01	VRTE-1501-01	VRTE-2000-01	VRTE-3000-01
Capacity	700VA 490W	1000VA 700W	1500VA 1050W	2000VA 1400W	3000VA 2100W
Input Plug	NEMA 5-15P	NEMA 5-15P	NEMA 5-15P	NEMA 5-20P	NEMA L5-30P
Input Connection	Fixed Power Cord				
Output Connection	6 x NEMA 5-15R			4 x NEMA 5-15R	
Battery Type & Rating	Sealed, lead-acid 7.2Ah/12V	Sealed, lead-acid 7.2Ah/12V	Sealed, lead-acid 9Ah/12V	Sealed, lead-acid 7.2Ah/12V	Sealed, lead-acid 9Ah/12V
Battery Quantity	2	3	3	6	6
Backup Time (full load)	7 min	6 min	5 min	6 min	5 min
Recharge Time	<4 hours to 90 %				
Dimensions in / mm W x D x H	16.8 x 16.7 x 3.3 428 x 426 x 84			16.8 x 24.8 x 3.3 428 x 631 x 84	
Weight lbs. / kg	32 / 14.6	38 / 17.3	39.8 / 18.1	69.5 / 31.6	72.6 / 33

120V 19" Rack Mount Models (1U)

Model Number	VRME-0700-01	VRME-1000-01
Capacity	700VA 490W	1000VA 700W
Input Plug	NEMA 5-15P	NEMA 5-15P
Input Connection	Fixed Power Cord	
Output Connection	3 x NEMA 5-15R	
Battery Type & Rating	Sealed, lead-acid 7Ah/6V	
Battery Quantity	4	
Backup Time (full load)	6 min	4 min
Recharge Time	<4 hours to 90%	
Dimensions in / mm W x D x H	16.9 x 20.7 x 1.73 428 x 525 x 44	
Weight lbs. / kg	34.1 / 15.5	

* A hardwire version of these models is available. For model number, substitute the last two digits of the model number for H1 (120V) or H2 (220V).

230V Tower Models

Model Number	VTWE-0700-02	VTWE-1000-02	VTWE-1500-02	VTWE-2000-02	VTWE-3000-02
Capacity	700VA 490W	1000VA 700W	1500VA 1050W	2000VA 1400W	3000VA 2100W
Input Plug	IEC C14 (10A)	IEC C14 (10A)	IEC C14 (10A)	IEC C14 (10A)	IEC C20 (16A)
Input Connection	Detachable Power Cord				
Output Connection	6 x IEC C13			8 IEC C13 + 1 IEC C19	
Battery Type & Rating	Sealed, lead-acid 7.2Ah/12V	Sealed, lead-acid 7.2Ah/12V	Sealed, lead-acid 9Ah/12V	Sealed, lead-acid 7.2Ah/12V	Sealed, lead-acid 9Ah/12V
Battery Quantity	2	3	3	6	6
Backup Time (full load)	7 min	6 min	5 min	6 min	5 min
Recharge Time	<4 hours to 90 %				
Dimensions in / mm W x D x H	6 x 16.5 x 9.4 152 x 420 x 238			8.9 x 16.7 x 14.2 225 x 428 x 360	
Weight lbs. / kg	29 / 13.5	35.7 / 16.2	37.4 / 17	69.5 / 31.6	72.6 / 33

230V 19" Rackmount Models (2U)

Model Number	VRTE-0700-02	VRTE-1000-02	VRTE-1500-02	VRTE-2000-02	VRTE-3000-02
Capacity	700VA 490W	1000VA 700W	1500VA 1050W	2000VA 1400W	3000VA 2100W
Input Plug	IEC C14 (10A)	IEC C14 (10A)	IEC C14 (10A)	IEC C14 (10A)	IEC C20 (16A)
Input Connection	Detachable Power Cord				
Output Connection	6 x IEC C13			4 x IEC C13 + 1 IEC C19	
Battery Type & Rating	Sealed, lead-acid 7.2Ah/12V	Sealed, lead-acid 7.2Ah/12V	Sealed, lead-acid 9Ah/12V	Sealed, lead-acid 7.2Ah/12V	Sealed, lead-acid 9Ah/12V
Battery Quantity	2	3	3	6	6
Backup Time (full load)	7 min	6 min	5 min	6 min	5 min
Recharge Time	<4 hours to 90 %				
Dimensions in / mm W x D x H	16.9 x 16.7 x 3.3 428 x 425 x 84			16.9 x 24 x 3.3 428 x 610 x 84	
Weight lbs. / kg	32 / 14.6	38 / 17.3	39.8 / 18.1	69.5 / 31.6	72.6 / 33

230V 19" Rackmount Models (1U)

Model Number	VRME-0700-02	VRME-1000-02
Capacity	700VA 490W	1000VA 700W
Input Plug	IEC C14 (10A)	IEC C14 (10A)
Input Connection	Detachable Power Cord	
Output Connection	4 x IEC 320 (10A)	
Battery Type & Rating	Sealed, lead-acid 7Ah/ 6V	
Battery Quantity	4	
Backup Time (full load)	6 min	4 min
Recharge Time	<4 hours to 90%	
Dimensions in / mm W x D x H	16.9 x 20.7 x 1.73 428 x 525 x 44	
Weight lbs. / kg	34.1 / 15.5	

10. Warranty

10.1 Limited Three-Year Warranty and Exclusions

Marathon Power warrants to the original purchaser, and not for the benefit of anyone else that this product at the time of its sale by Marathon Power is free of defects in materials and workmanship for three (3) years (batteries for 2 years within the USA, Canada and Mexico, otherwise 1 year) from the original purchase date. Marathon Power will correct such defects by repair or replacement, at its option, if within such three year period the product is returned prepaid and all warranty claim instructions are followed. This warranty excludes labor for removal or reinstallation of this product. This warranty is void if this product is installed improperly or in an improper environment, overloaded, misused, opened, abused, or altered in any manner, or is not used under normal operating conditions or not in accordance with all labels or instructions. There are no other or implied warranties of any kind, including merchantability and fitness for a particular purpose, but if any implied warranty is required by the applicable jurisdiction, the duration of any such implied warranty, including merchantability and fitness for a particular purpose, is limited to three years. Marathon Power is not liable for incidental, indirect, special or consequential damages, including damage to, or loss of use of, any equipment, lost sales or profits or delay or failure to perform this warranty obligation.

10.2 Limitations & Claims

This warranty does not cover any Marathon Power UPS or any properly connected electronic equipment which has been improperly installed, overloaded, abused or altered in any manner, or is not used under normal operating conditions, or in accordance with any labels or instructions, and does not cover any damage to properly connected electronic equipment resulting from a cause other than a "surge".

Damage caused by failure to provide a suitable installation environment for the product (including, but not limited to, lack of a good ground) will not be covered by this warranty. This warranty does not apply to damage caused by direct lightning strikes, or damage caused by electrical disturbances that exceed published product specifications. These products are intended to limit the maximum amplitude of transient voltage surges on power lines to specified values. They are not intended to function as surge arrestors. The UPS is intended to be installed on the load side of the service entrance and has been tested to verify that transient voltage surges are limited when subject to non-repetitive transient voltage surge events. This warranty excludes any incidental, indirect, special or consequential damages, including without limitation, labor for removal or reinstallation of the Marathon Power UPS or any connected electronic equipment, data loss or alteration loss of equipment use, lost sales or profits and any such damages for delay or failure to perform this warranty obligation. This warranty is in lieu of and excludes all implied warranties of merchantability or fitness for use. In addition, the warranty does not cover restoration of lost data and reinstallation of software. Some states may not allow the exclusion or limitation of incidental or consequential damages or other remedies, so the above exclusions or limitations may not apply to you.

Take the following steps to file a warranty claim: Contact us at Marathon Power, Inc., Attn: Returns, 2538 E. 54th Street, Huntington Park, California 90255 or call (310) 689-2328 within 30 days of the occurrence. Be prepared to provide detailed information about the event, any damage, the UPS model number, purchase date and location. You will then be provided with a Return Authorization Number (RAN), and be instructed to forward your proof of purchase (receipt), an explanation of the event and your UPS. If Marathon Power determines that the damage was due to a "surge", we may request that all connected equipment be submitted for evaluation. Marathon Power is not responsible for shipping costs. In the event that the equipment has been damaged by a "surge" Marathon Power will reimburse you for repair or replacement at fair market value (on a pro rata basis) as indicated by the respective amounts above. The warranty coverage is above and beyond, only to the extent needed, of that provided by any other source, including but not limited to any connected equipment coverage, any manufacturer's warranty or insurance policy. To receive payment for repair to damage due to a "surge," the original purchaser should (upon prior approval from Marathon Power) have such equipment repaired by an authorized service center of such equipment's manufacturer. The original purchaser will submit a repair bill along with a statement from the repair facility documenting the nature of the damage and how it was sustained to said equipment.



MARATHON
P O W E R

Marathon Power, Inc. 2023

2538 E. 54th Street
Huntington Park, CA 90255

Office: 310-689-2328

Fax: 310-689-2329

support@marathon-power.com

www.marathon-power.com